

POOLSPA

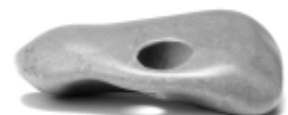

Multi-person SPA bath  
gutter option

Installation and instruction manual



Dear Customers,

Thank you for the trust you have us shown by purchasing our product. We have put all our efforts to ensure that this product fully meets you expectations.

We have been offering world class quality products for many years. The endurance, reliability and safety of our products have always been of the greatest importance to us. The highest quality of materials used for our products, interesting stylistics and ergonomics of our products ensure that your bath will be fully comfortable.

We wish you satisfaction from using our products.

## CONTENTS

I. GENERAL INFORMATION .....	3
II. TECHNICAL DRAWINGS.....	3
1. SAFETY RULES .....	6
2. SITE PREPARATION .....	6
3. INSTALLATION OF SPA BATH AND ADDITIONAL EQUIPMENT .....	6
4. CONNECTION TO ELECTRICAL SYSTEM.....	7
4.1. Earthing.....	12
4.2. Supply cable.....	12
4.3. Supply connection .....	12
5. WATER CONNECTION.....	12
6. FILLING AND DRAINING OF BATH.....	13
7. VENTILATION SYSTEM .....	14
8. ANTI-FROST PROTECTION .....	14
9. SPA BATH MASSAGE SYSTEM .....	14
10. WATER FILTERING SYSTEM.....	14
11. HEATER AND LIGHTING .....	15
12. CONTROL SYSTEM .....	15
12.1 STB-3 Control System.....	16
13. MAINTENANCE OF ACRYLIC COATING.....	18
14. DISINFECTION .....	18
15. MAINTENANCE OF WATER.....	19
GUARANTEE CONDITIONS .....	21
TECHNICAL PRODUCT SHEET .....	23

This Instruction Manual contains information necessary for installation and use of a SPA bath. All sections of the Manual should be carefully reviewed prior to start up of the hydro-massage system.

The SPA bath EXCLUSIVE option is designed for private use.

## I. GENERAL INFORMATION

### AIR MASSAGE:

- blower 1,2 kW 1 x 230 V.
- air openings in SPA bath bottom and seats

### WATER MASSAGE:

- 1,5 kW hydromassage pump, (SPA Olivia, Sunflower - 2 pumps)
- nozzles: 6 – 32 pcs.
- air controlling devices.

### WATER FILTRATION AND HEATING:

- overflow gutter with a protective grille
- equalising tank with an automatic filling valve
- 0,75 kW 1 x 230 V filtrating pump
- sand filter F500
- UV lamp,
- 9 kW water heater with a flow metering and overheating metering sensor (SPA Vesta, Olivia - heater 12 kW)

### Underwater LED light or LED spotlight – 24 points

### CHARACTERISTICS:

#### - Capacity of SPA baths with gutters:

Janette:	900 litres	Vesta:	1600 litres
Octavia:	1050 litres	Olivia:	2100 litres
Victoria:	1100 litres	Sunflower:	2000 litres
Classic:	1400 litres	Olimpia:	2000 litres
Natalie:	1300 litres		

- tank capacity: 1100 litres
- tank dimensions: 1400 x 750 x 1400 mm
- number of users: 3-8,
- electrical supply: 3 x 380 V
- maximal power consumption: ~15 kW (SPA Olivia: ~18 kW)

## II. TECHNICAL DRAWINGS

Janette

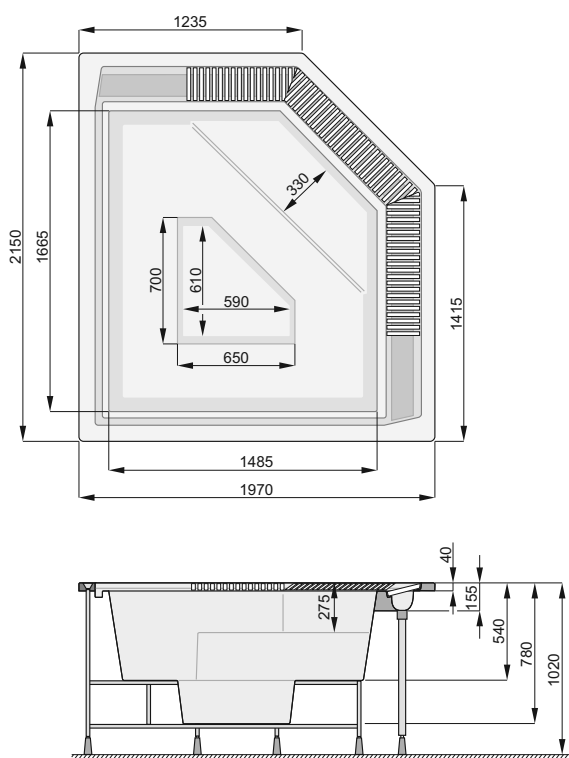

Octavia

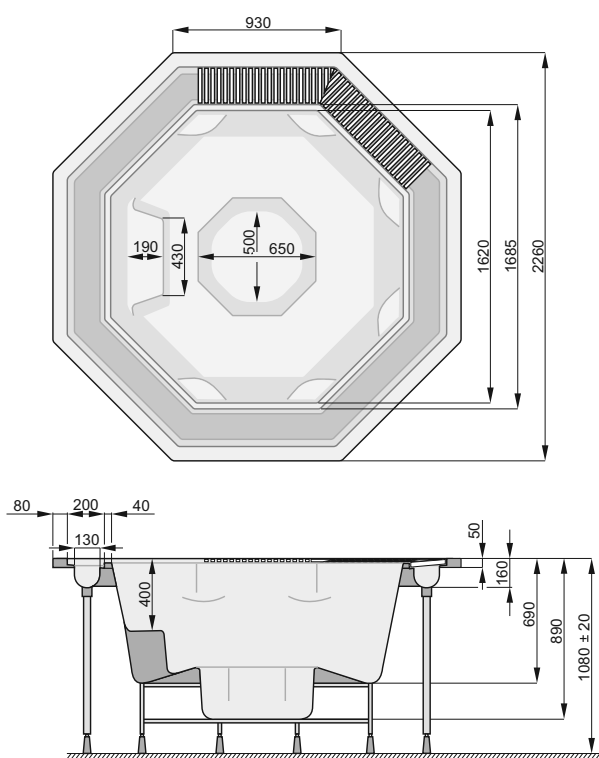

Victoria

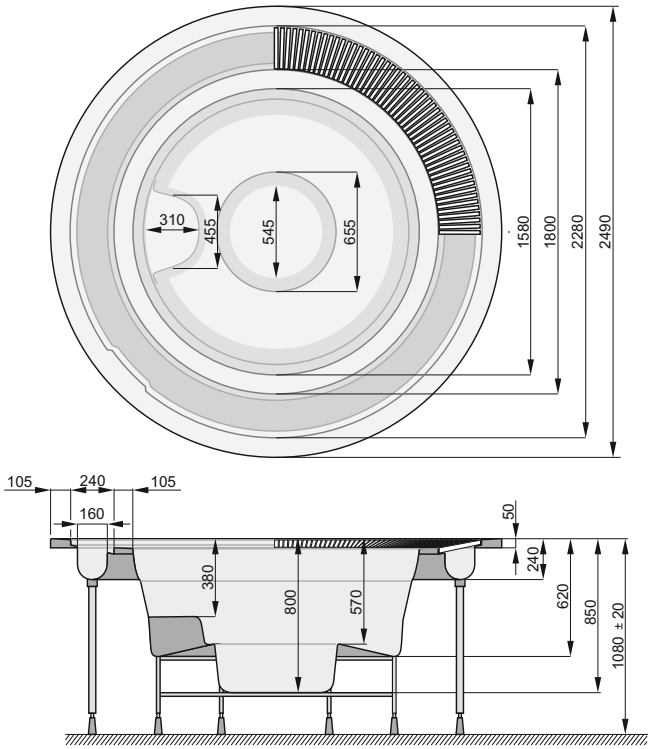

Classic

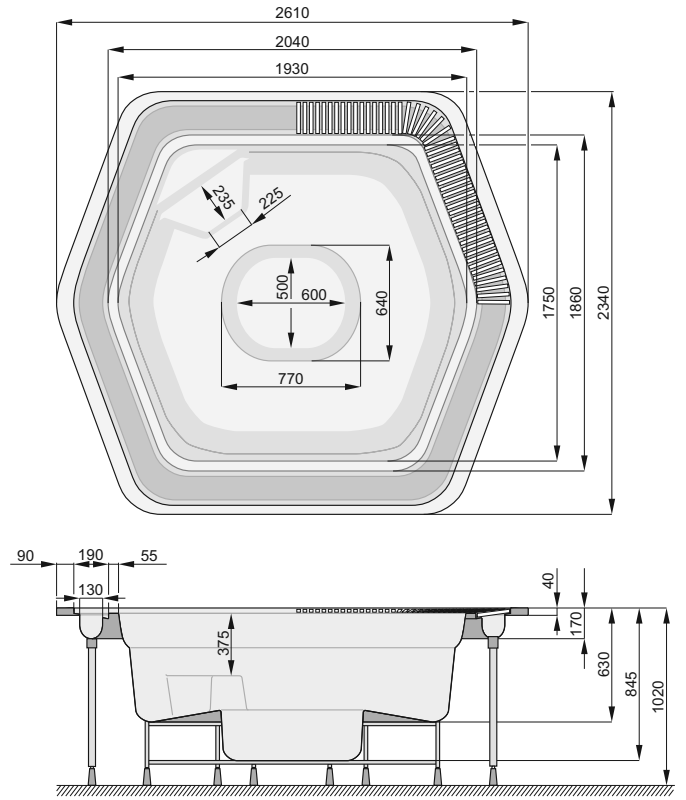

Natalie

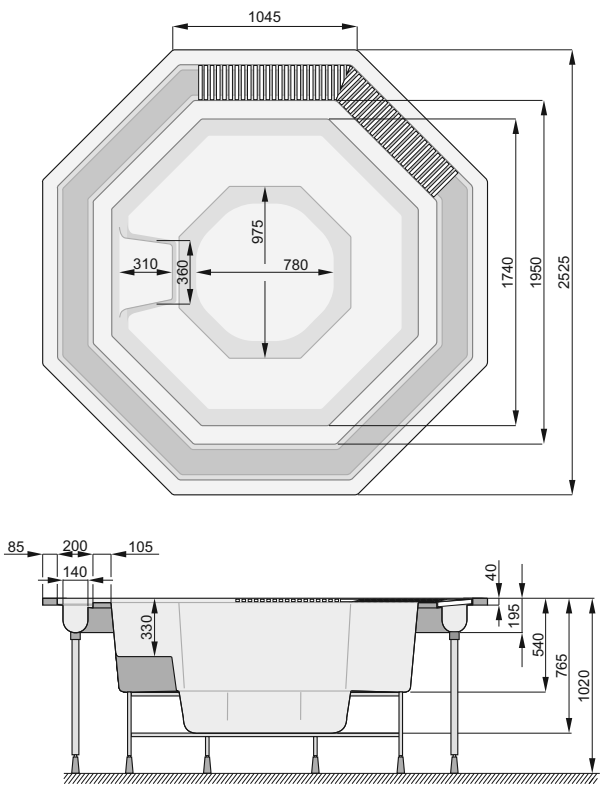

Vesta

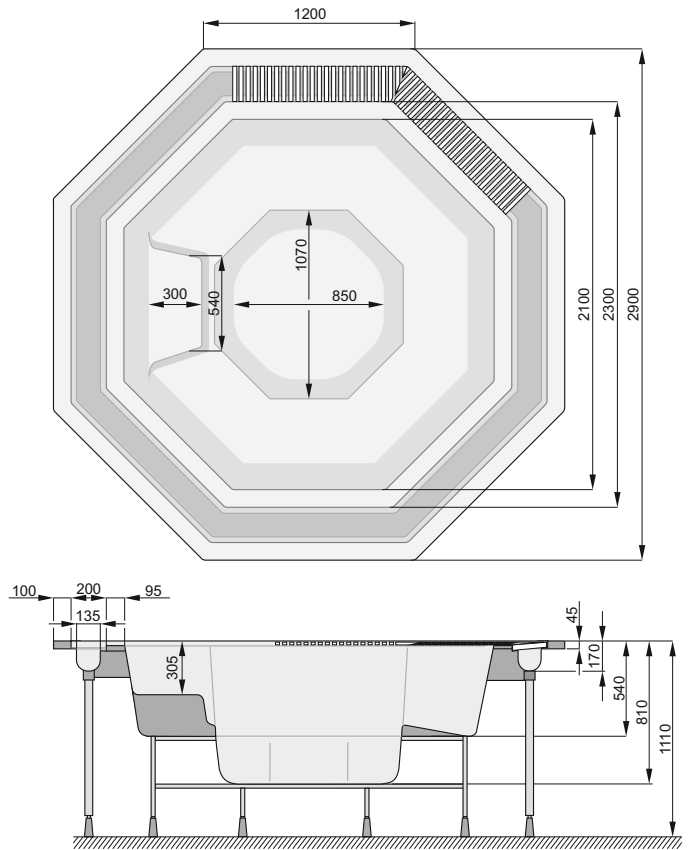

Olivia

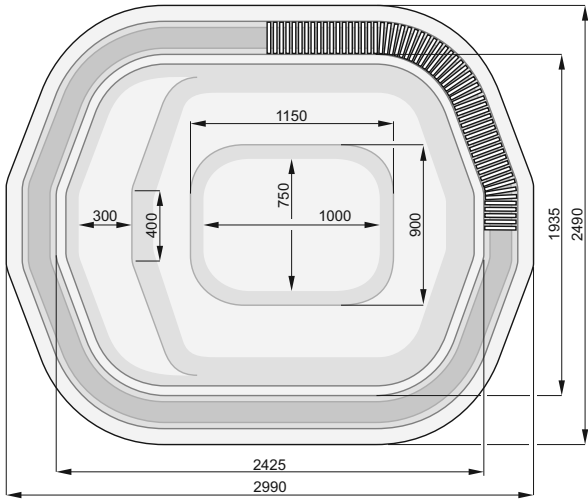

Sunflower

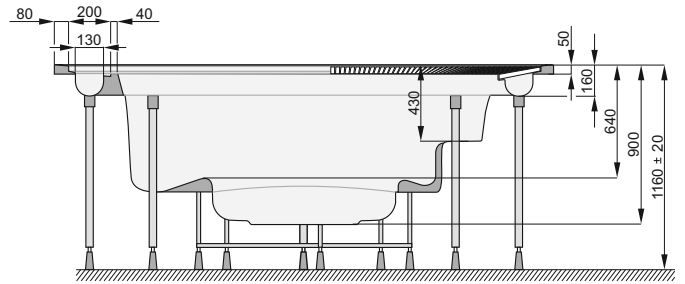
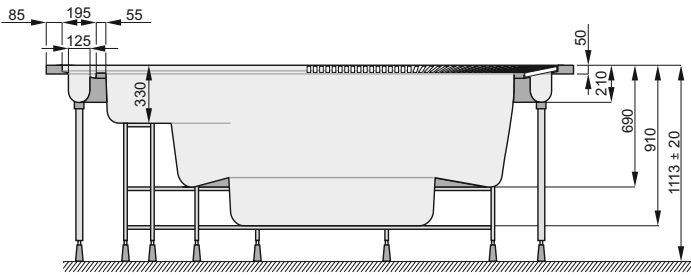
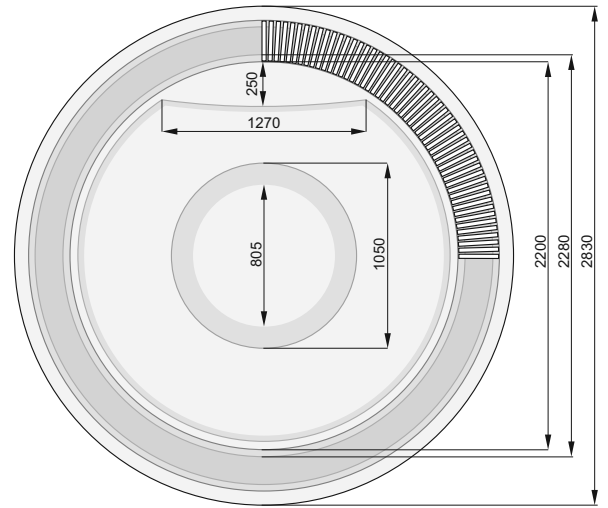

Olimpia

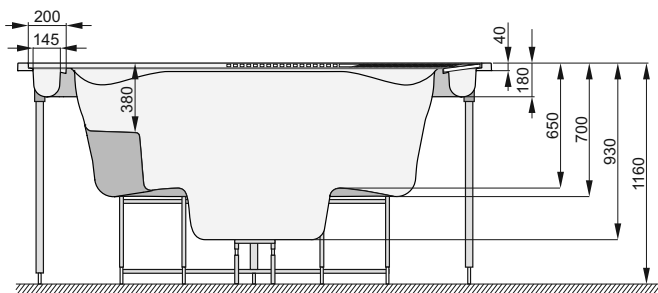
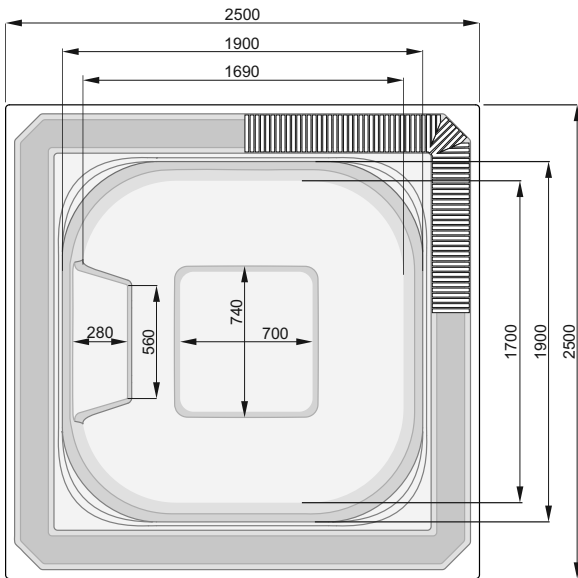

## 1. SAFETY RULES

The SPA bath will be delivered to the Customer in its original package. After the package is removed, one should check the SPA bath carefully before commencement of installation and report all spotted problems.



**Do not move the bath and the filtrating equipment by holding them with the piping.**

**The bath should be always placed on its legs, never on its side.**

**Make sure the bath is properly protected in the course of installation works to be carried out near the bath.**

Connection to the electrical system and the water connections should be carried by licensed installation staff.

## 2. SITE PREPARATION

- The SPA bath can be used both in closed premises and in open areas.
- The bath should be installed on a hard surface ground, to avoid settling down.
- In case of a SPA bath installed in closed premises, make sure there is enough space to bring in the equipment.
- Dimensions of the foundation slab for the SPA bath should enable the installation staff to install properly the legs, the pipes and the cables (allowing for access to these elements).
- Consider the drainage method to be used for the SPA bath. The base should be levelled.
- Check the materials used for walls and ceiling of the premises. They should be resistant to vapour released during operation of the SPA bath.
- Due to likelihood of water splashing during use of the SPA bath, the base should be made of a highly water resistant material, such as ceramic floor tiles or PVC coating. In case of carpet flooring, such material should be properly protected against bacteria breeding in humid environments. Special carpets or carpet flooring used in sailing industry should be used. Wooden parquet or any other timber flooring is not recommended, unless it is specifically treated, like timber used for gardening or external use in construction. Make sure the floor incline towards the floor drain is 2%.

## 3. INSTALLATION OF SPA BATH AND ADDITIONAL EQUIPMENT

- To ensure proper operation of a SPA bath, it should be installed on a durable and carefully levelled base (with an incline towards the floor drain), e.g. on a 10 cm thick cement slab, to avoid settling down of the floor base.
- The weight of the SPA bath when filled with water, with 3 users inside, is approximately 1200 kg. The pressure on the floor base is then equal to 360 kg/sq m.
- Having defined the height of installation for the bath, prepare a cement block for support of both fixed and telescopic extended legs.
- The dimensions of the pit and of the cement block need to be large enough for the installation staff to properly install the legs, the pipes and the cabling.
- After installation of telescopic extended legs the bath edge should be levelled.
- Fix the legs to the cement block to make sure they are not accidentally displaced.
- All connections between the additional equipment and the bath must be made by means of pipes and fixtures connected by means of gluing. Metal pipes and elements cannot be used.
- Tightness of all connections needs to be checked once the bath is filled with water.
- The pit around the bath cannot be filled with any type of material. Access to all pipes and connections must be ensured.
- The additional equipment must be installed with due care, preferably in an air-conditioned room, not farther than 10 m from the bath in horizontal plan. The level of the foundation slab for additional equipment cannot be higher than the level of the bath slab. Additional equipment should not be also installed lower than 2.5 m below the bath level. In case of greater distances we recommend to contact the Manufacturer (provision of another filtrating pump will be necessary).
- It is recommended that the floor incline should be located near the place, where SPA bath will be installed, below the level of the bath.

Fig. 1. Bath installed on the floor slab level

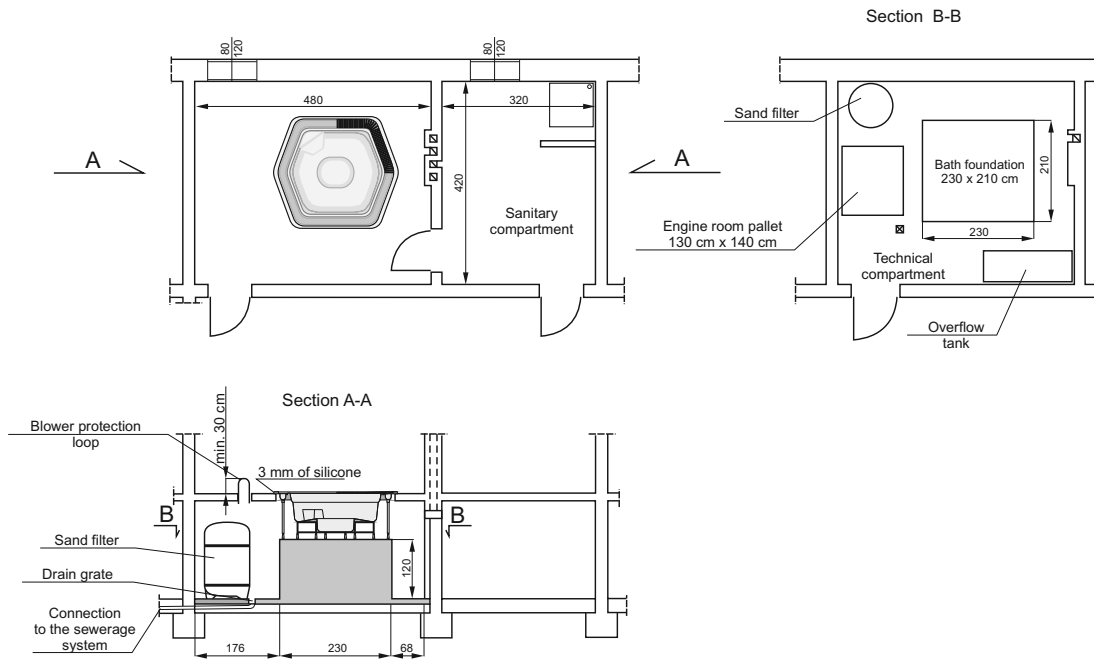
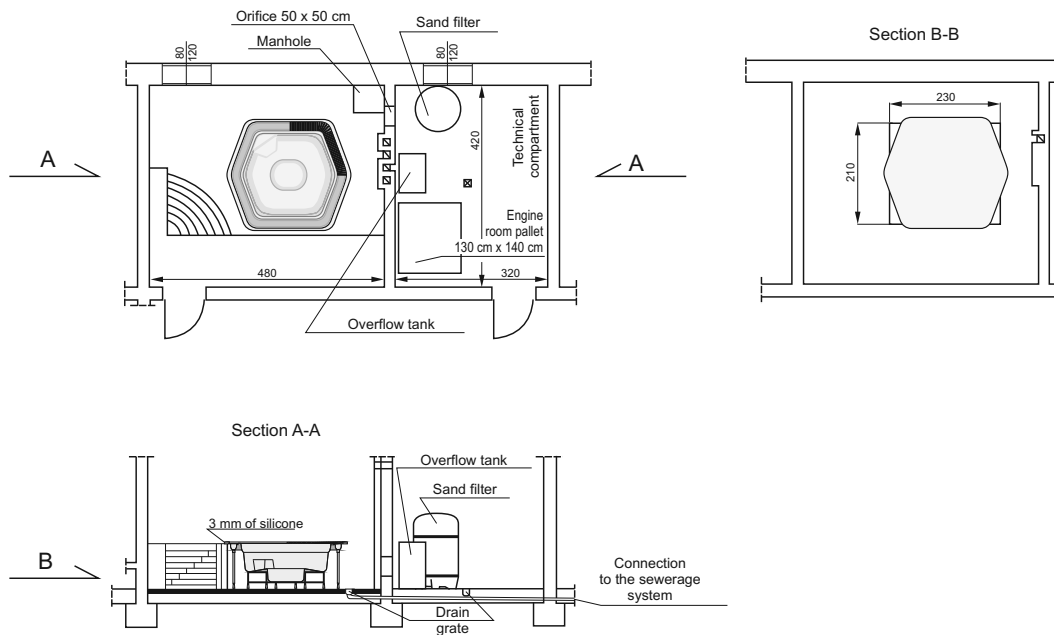

Fig. 2. Bath installed on top of the floor slab



#### 4. CONNECTION TO ELECTRICAL SYSTEM

Connection of the electrical system in the premises and the electrical system of the device should be made by a licensed electrician.

The internal electrical connections of the additional equipment are factory made.



The electrical system of the SPA bath should be secured with a differential-current safety fuse of the rated breaking current value of 30 mA and with a magnetic and thermal 63 A breaker with a mechanism enabling disconnection of all poles, with the opening distance of at least 3 mm. Both breakers should be installed out of the safety zones as indicated on Fig. 7.

Fig. 3. Electrical scheme of SPA bath Exclusive version: 1 hydromassage pump, multicolour LED light

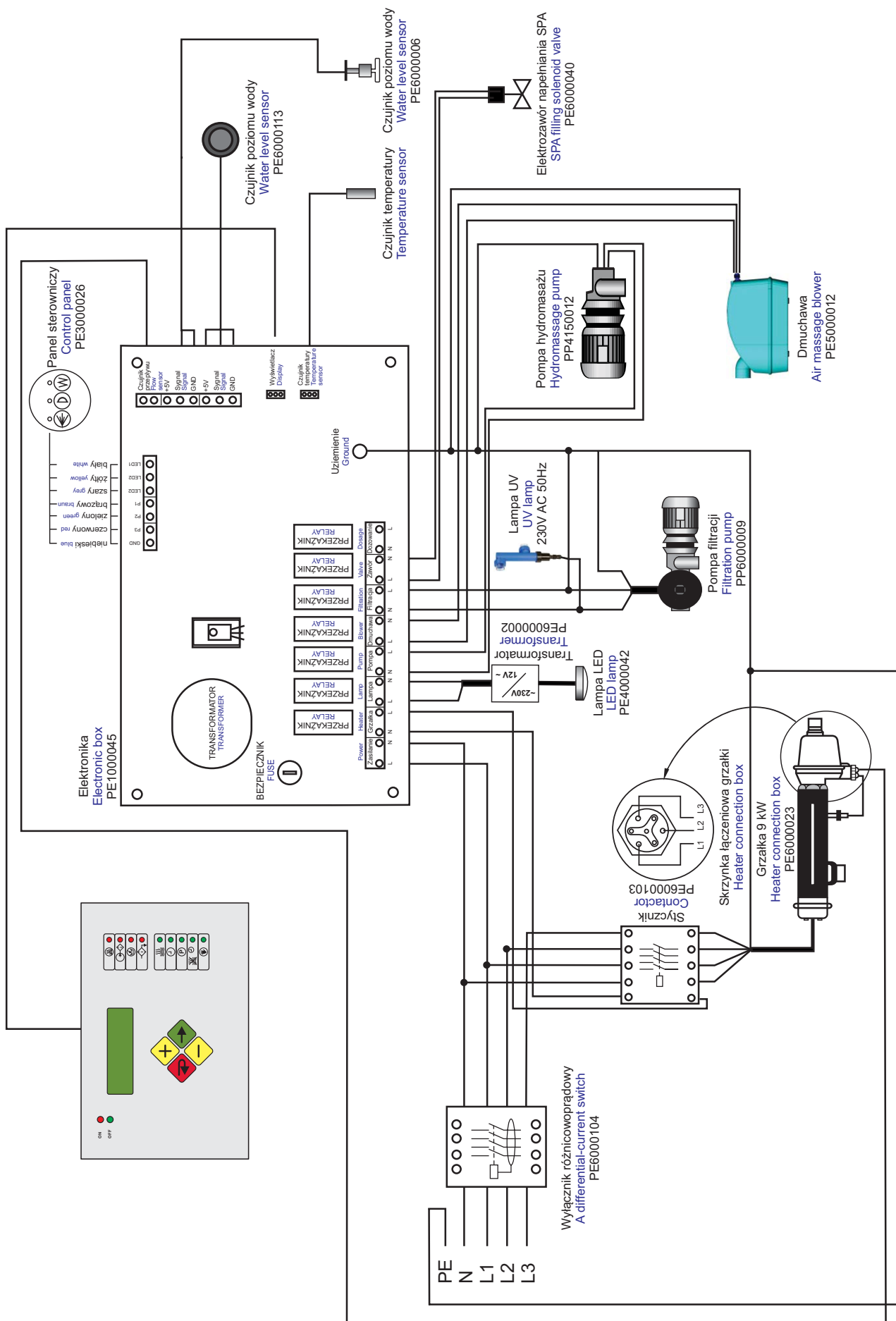



Fig. 4. Electrical scheme of SPA bath Exclusive version: 1 hydromassage pump, LED spotlight – 24 points

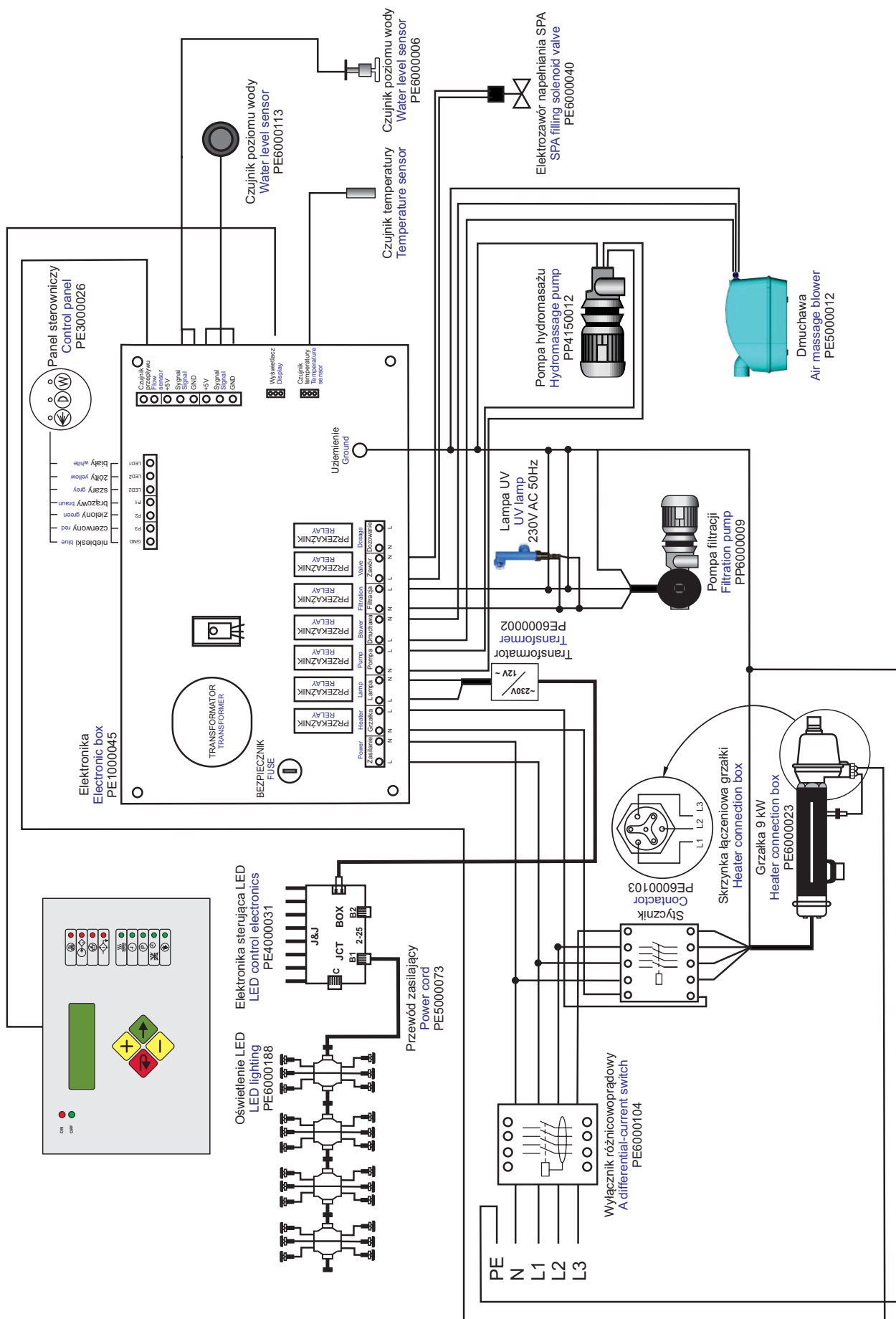

Fig. 5. Electrical scheme of SPA bath Exclusive version: 2 hydromassage pumps, multicolour LED light

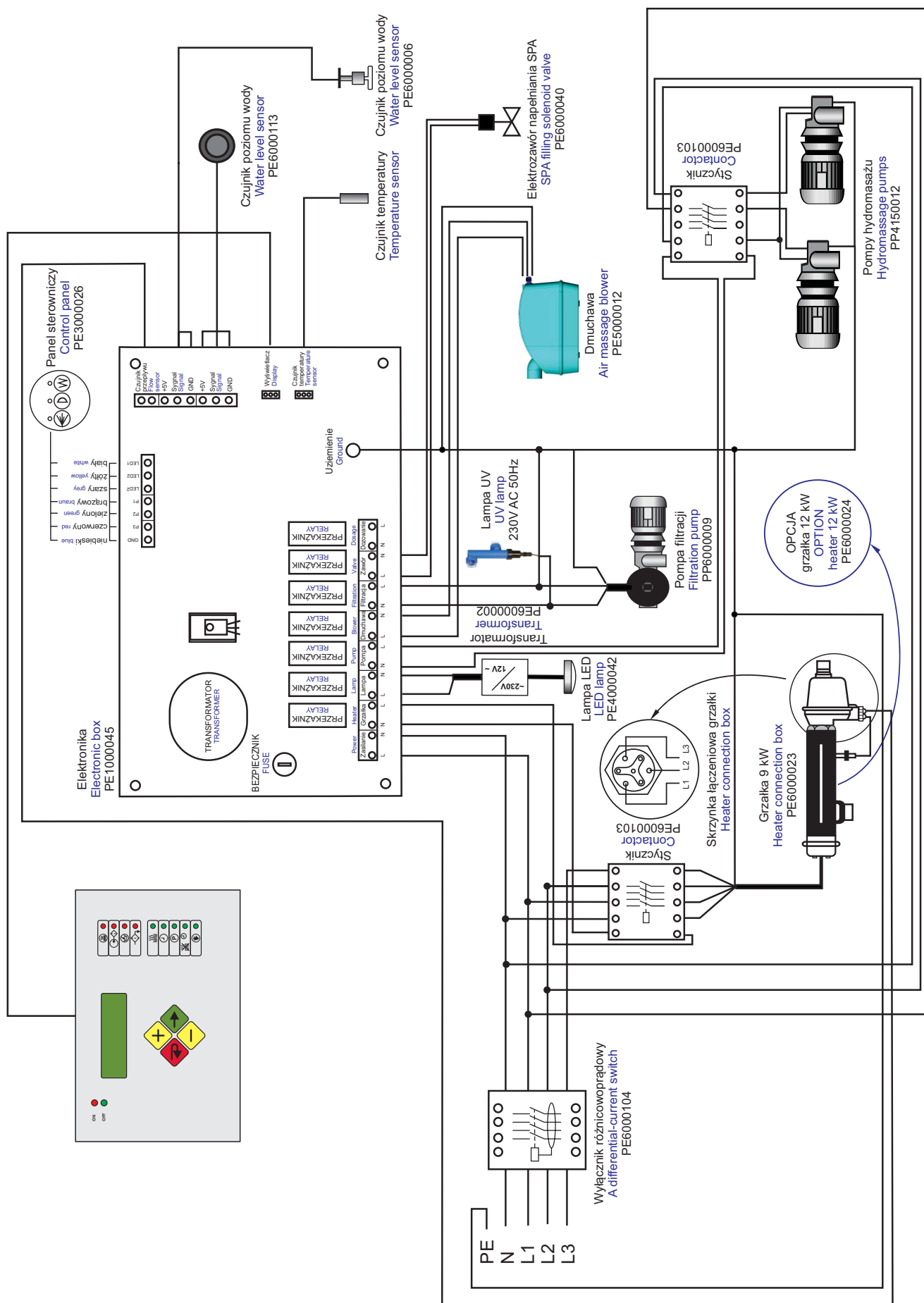
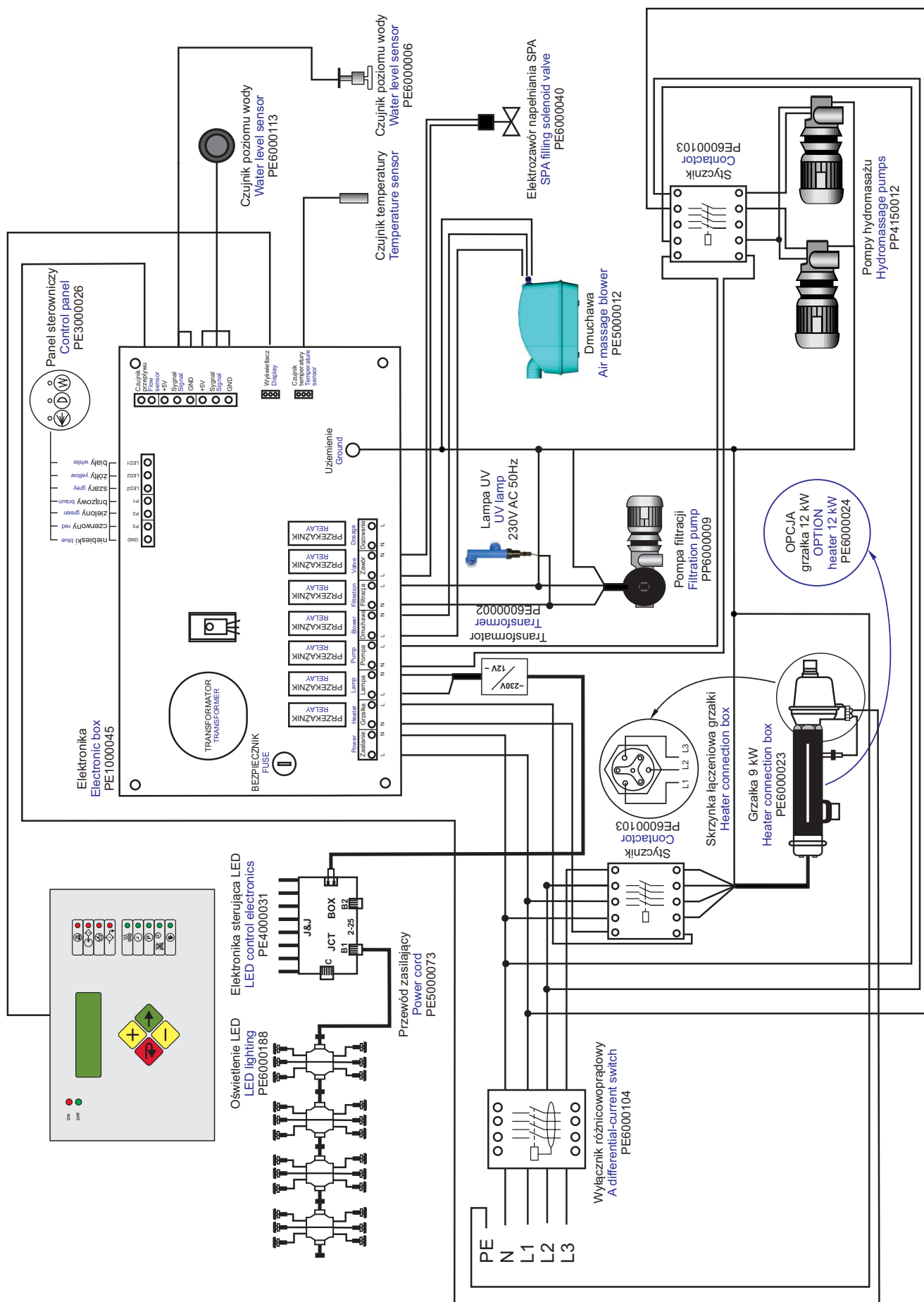

Fig. 6. Electrical scheme of SPA bath Exclusive version: 2 hydromassage pumps, LED spotlight – 24 points



#### 4.1. Earthing

To ensure the proper operation of the differential current safety fuse, an earthing system must be installed in the building, as per the valid regulations, as well as an equalizing connection.

#### 4.2. Supply cable

The SPA bath supply cable should be permanently fixed to the electrical network.

The electrical system must be installed in compliance with the valid requirements for low voltage systems. It is therefore important to remember there will be 4 safety zones where a SPA bath is installed, as per Fig. 5 below. As shown on the drawing, the supply cable should be located in zone 3 or on the suspended ceiling, over the level of 2.25 m.

#### 4.3. Supply connection

The following issues should be considered when connecting power supply:

- Electrical power supply for the SPA bath must be permanently fixed to the electrical system.
- A proper cable, in compliance with the requirements for the low voltage systems, should be used. Remember that the yellow and green earthing wire should be at least 40 mm longer than the phase and the neutral wires, in order to be disconnected as the last one in case of a sudden pulling movement.
- If supply connection is provided under the SPA bath, it can be made only with a system ensuring at least IPX5 protection level and such connection should run 20 cm above the floor level.

Fig. 7.

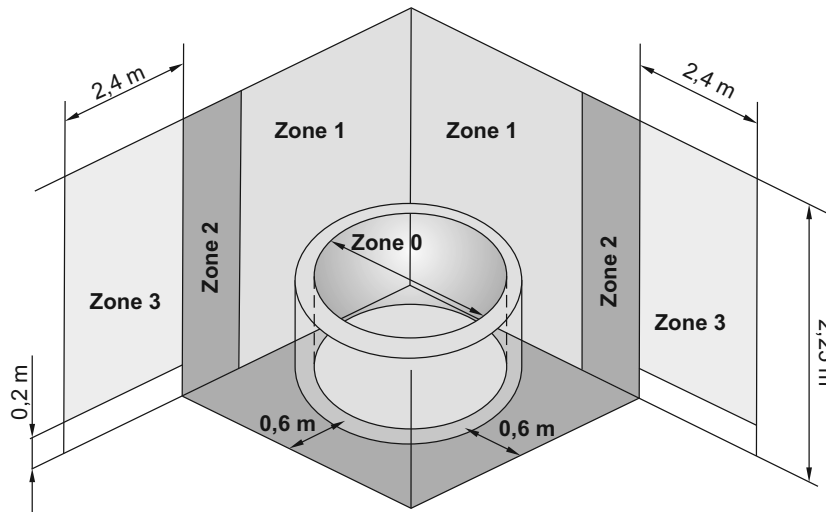

It is very important to ensure complete tightness (IPX5 level) of electrical connections.

### 5. WATER CONNECTION

Water connections should be made of PVC pipes fixed with a proper adhesive for such a material. Do not use metal pipes.

Make sure the filling connection and the drainage connection of the SPA bath do not have air pockets. The drainage system is to ensure perfect draining of the SPA bath. If possible, an air trap can be installed to avoid unpleasant odours.

Moreover, the filling and drainage system should be provided with a return valve, which will not allow for water flow in reverse direction.

All bath connections and additional equipment connections are numbered in sequence. The bath and additional equipment elements should be connected as indicated by the numbering. It is recommended to install valves between all connections of the additional equipment, in order not to have to drain the SPA bath prior to maintenance operations.

The PVC pipe connecting to the blower must be located (partly) on the level of at least 30 cm above the top SPA bath edge, to avoid water flowing in reverse direction.

Upon completion of installation works, the equipment should be set in operation and the tightness of all connections should be checked. Mark the water level in the bath and check after 24 hours if the water level has dropped.

Check whether the motor's operation direction is as required; if not, change the clamp phases.

Check if the nozzle pressure is as required. In case of a block, eliminate the cause prior to fixing the bath in position.

## 6. FILLING AND DRAINING OF BATH

The air blower system must never be used for filling the SPA bath.

The SPA bath can be permanently fixed to the water supply line or can be filled by means of a disconnectable flexible hose, fixed exclusively for filling purposes.

The SPA bath with a gutter is filled by means of a ½" pipe in the tank. The pipe should be permanently fixed to the water supply line, in order to enable automatic tank filling in case of dropping water level.

The SPA bath drainage pipe should be connected to the sewage system in the premises or in the flat. Use of an air trap is recommended to avoid unpleasant odours.

Fig.8. SPA baths – connections

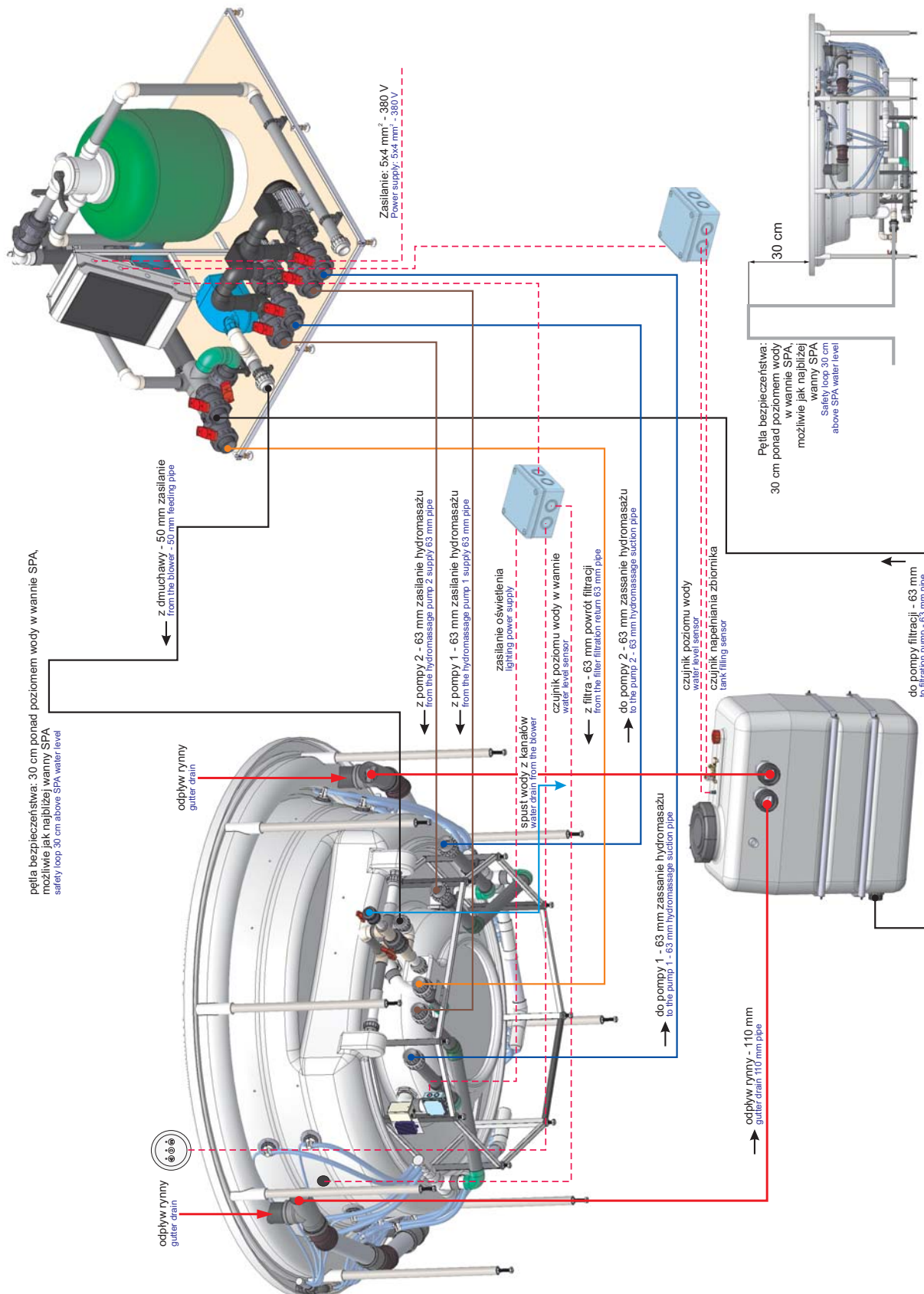

## 7. VENTILATION SYSTEM

High water temperature in the SPA bath (maximum 40°C) will cause emitting of big amounts of vapour.

An efficient ventilation system should be provided in the room where the SPA bath is installed. Otherwise, installation of a steam condenser is recommended, to keep air humidity on the same level and avoid vapour condensation on the ceiling and on the floor.

If timber elements are installed in the room, to ensure proper maintenance, the relative humidity in the room should not exceed 65%.

During the use of the SPA bath, due to vapour emitting caused by the hydromassage system and movement of water, the humidity level will reach 90 or 95%.

Air humidity may be maintained at fixed level by means of fans controlled by hygostat or dehumidifier devices, selected as per the size of the room. Distributor companies or installation staff can advise on this issue. Installation of vapour condensators is not necessary in premises with air-conditioning systems. These devices will also not be necessary for baths installed outdoors or in open premises.

## 8. ANTI-FROST PROTECTION

If the SPA bath is installed outdoors, there is a risk of freezing in winter time; the following recommendations should therefore be considered:

- If the heating system proves to be ineffective due to external conditions, both the bath and the pipes, the pump and the filters must be drained completely. Otherwise the pipes may crack as a result of ice expanding when freezing.
- In order to defrost the system, do not use hot water on pipes and on the bath. A sudden change of temperature might damage the material of which these elements are made. The frozen elements must defrost by themselves, in ambient temperature.
- Do not activate the pump or the blower if there is a risk of frozen water deposits remaining inside the system.
- Do not try to turn valves if potentially frozen. Otherwise, due to ice expanding during freezing, the valves may be damaged and the system will become untight.
- Address the installation team to find out about installation of a constant heating system.
- If the heater is to be constantly on, it is recommended to ask the installation team about possibility to install frost sensors in case of a power supply failure or disconnection of the heater or of the filtration pump.
- Don't use any anti-frost fluids which do not have the relevant sanitary guarantees.

## 9. SPA BATH MASSAGE SYSTEM

The SPA bath has two massage systems: an air massage system and water massage system.

The **water massage** system is composed of the following elements:

- a unit of 6-32 water-air nozzles supplying water and/or water and air mixture to the SPA bath water area;
- a filtration pump and a hydromassage pump, forcing water circulation in the whole water circuit towards the centre of the SPA bath;
- water aerating controllers (by Venturi), installed on the top edge of the SPA bath, used for water aeration level regulation. In order to support the heating system in winter conditions, these controllers should be closed;
- a water suction head.

The **air massage** system is composed of 100 small diameter openings through which the air is pushed into the SPA bath.

## 10. WATER FILTERING SYSTEM

The filtration circuit is composed of the following elements:

- an overflow gutter with a covering grille and an overflow tank
- sand filter F500 with six-function valve
- a filtration pump
- UV lamp
- a water suction head
- PVC pipes and fixtures.

The **overflow gutter** is an integral part of the SPA type bath and is provided for drainage of water from the bath to the equalizing tank, to which it is connected by means of a 110 mm diameter pipe. The covering grille on the overflow gutter protects the filtering system against penetration of waste and also forms a decorative element.

The **overflow tank** is used for collection of water pushed out by the users taking the bath. A standard size overflow tank (1100 litres) to be used for all types of SPA baths with overflow gutters manufactured by POOL-SPA is to be installed in the engine room. A 63 mm sewage connection should be provided in the place where the tank is to be installed (for the tank safety release purposes).

The overflow tank is provided with water level sensors, a meter indicator and the following connections:

- a tank inlet, 110 mm diameter, in its top or side wall,
- a 63 mm diameter drain, in its bottom or side wall,
- a safety release connection, 63 mm diameter, in a higher part of one of the side walls.

**Six-function valve** enables filter maintenance and controls its operation. During the standard operation the valve is set on filtration. Setting the valve into various position, performs a variety of maintenance functions at the filter, such as washing of the filter (cleaning sand deposits) and circulation (the flow of water with avoiding the sand deposit for rapid forced circulation in the pipeline).



**After back washing, check pH and the chlorine level in the water.**

**The sand in the filter should be replaced every 2-3 years.**

### Schematic drawing of the six-function valve

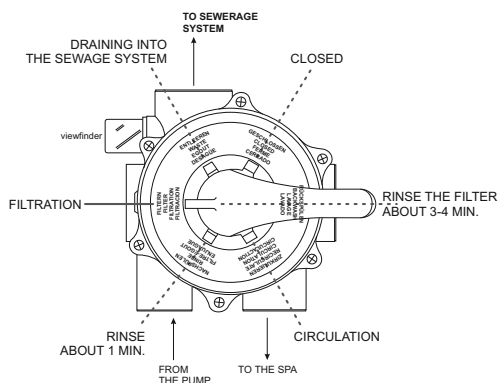

FILTERN, FILTER, FILTRATION, FILTRACION - filtration (normal operation)  
 RÜCKSPÜLEN, BACKWASH, LAVAGE, LAVADO - filter cleaning  
 ENTLEEREN, WASTE, EGOUT, DESAGÜE - draining into the sewage system  
 NACHSPÜLEN, RINSE, FILTRE-EGOUT, ENJUAGUE - sand bed rinsing and makeup  
 ZIRKULIEREN, RECIRCULATE, CIRCULATION, CIRCULACION - circulation – the filtration system operates without the filter  
 GESCHLOSSEN, CLOSED, FERME, CERRADO - closed (do not start the filtration pump)

### Maintenance of filtrating pump

The filtrating pump should be cleaned as often as required for its operation. Deposits will collect in the pump basket.

In order to clean the filtration basket of the pump, remove the pump cover and filter to remove impurities.

### Substances used for transportation of SPA bath

During transportation, for protective purposes, the acrylic surface is covered with a thin layer of wax. Prior to the commencement of use of the SPA bath, all surfaces which are to receive silicone should be cleaned with an organic dissolvent (grease will disable connection).

Metallic elements have been coated with silicone oil for protective purposes. Prior to filling of the SPA bath with water, the oil should be removed by means of a de-greasing agent.

## 11. HEATER AND LIGHTING

In case of activation of the thermal fuse of the heater, wait until the heater has cooled down, remove the protective stopper and press the RESET button on the heater cover body.

The SPA bath lighting is composed of a underwater LED light or LED spotlight – 24 points.

## 12. CONTROL SYSTEM

The SPA bath control system is composed of a control panel with three on and off functions:

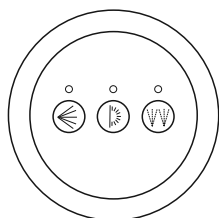

**1. Water massage:** switching on and off the hydromassage pump and the filtrating pump, thus activating the water massage system. When the water massage system is on, the red diode will be on. This function is activated only when there is sufficient amount of water in the SPA bath.

**Water massage with air: the amount of air can be regulated by air controllers, located on the top surface of the SPA bath.**

**2. Air massage:** switching on and off the jet blower required for the air massage system. When the air massage system is on, the red diode will be on. This function is activated only when there is sufficient amount of water in the SPA bath.

**3. Underwater lighting:** switching on and off the underwater lights inside the SPA bath. The lamp will be switched on only when there is sufficient amount of water in the SPA bath.

## 12.1. STB-3 Control System

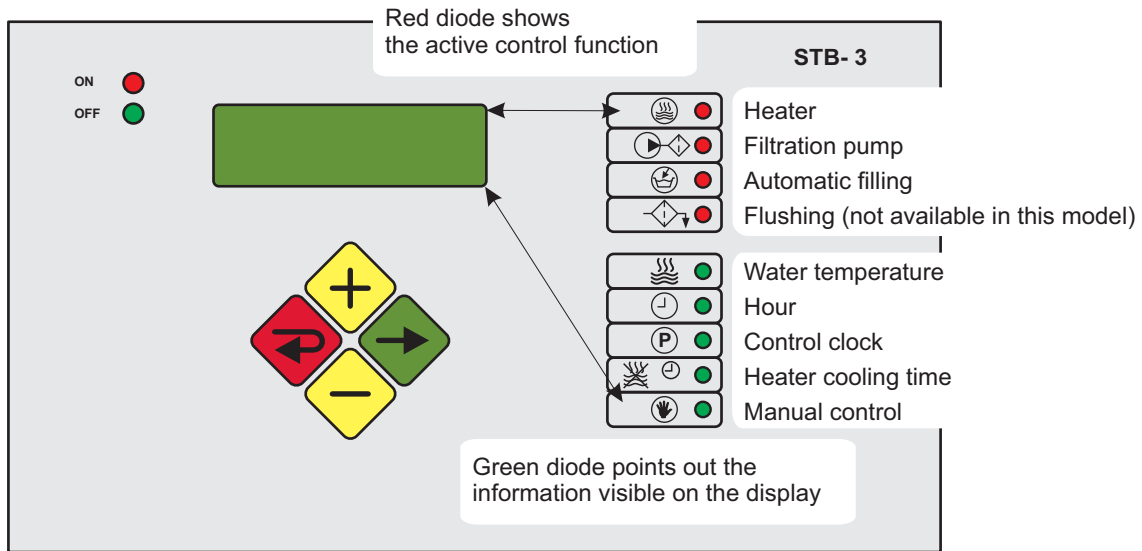

STB-3 system will once a week control the temperature, the water level and the filtrating process of the SPA bath.

For the purpose of everyday temperature regulation and water filtration level regulation, one may choose one of the two cycles. It is recommended to choose the low (L) temperature level filtration process cycle (factory default setting of SPA bath) or the high (H) temperature level filtration process cycle. Both L and H symbols cover the temperature value range of 0°C to 42°C, but the system operates properly within temperature range of 6°C to 36°C, with the accuracy of  $\pm 0.5^\circ\text{C}$ .

When the system functions are activated, the respective red diode will be on.

Heater

Filtrating pump

Automatic filling

Rinsing (not available for this SPA bath model)

The display will show the detailed information on the selected function. The respective green diode will be on:

Water temperature

Time

Control clock

Heater cooling time

Manual control

### 12.1.1. Display information

In standard mode, the display shows the parameters of the selected function and the green diode is on. The user may change the function by short pressing the button. .





### 12.1.2. Available functions

- Temperature: current water temperature is presented as the first and the second digit (big digits) and the memory set water temperature value is presented as the third and the fourth digit (small digits).
- Time: showing the current time (24-hour mode).
- Control clock: presenting a sequence of all memory set programme parameters (day number: 1 – 7), programme number (1 - 2), programme temperature level (L or H), time of filtrating process commencement, time of filtrating process completion for the programme.
- Heater cooling time: showing memory set info on the value of time added to the selected filtrating time and required for heater cooling when switched off (between 0 to 50 minutes).
- Manual control: subject to sufficient water level in the SPA bath, with the water level sensor activated, the filtrating pump is switched on by single pressing of , button; subsequent pressing of button will switch on the heater. Pressing of , button will cancel the above settings.











### 12.1.3. Programming

After the function is selected, holding pushbutton  for at least 3 seconds activates function programming mode.

Pushbuttons  and  are used for parameters change. The pushbutton  changes a parameter for a consecutive one; when all function parameters are modified, the system exits programming mode and modified parameters remain saved. The pushbutton  is used to exit programming mode with changes not saved, except control clock function  for which the pushbutton serves to exit programming mode with changes saved.











#### 12.1.3.1. Water temperature setting

The function is selected with pushbutton  Changing L and H level values at any moment within 0°C to 42°C range is possible.

1. Push pushbutton and hold  it over 3 seconds.
2. With  or  pushbutton set L level temperature (low, economic).
3. Pushbutton .
4. With  or  pushbutton set H level temperature (high, comfort temperature).
5. Pushbutton .



#### 12.1.3.2. Hour set

This function is selected with pushbutton .

1. Push pushbutton and hold  it over 3 seconds.
2. With  or  pushbutton set hour (A).
3. Pushbutton .
4. With  or  pushbutton set minutes (B).
5. Pushbutton .
6. With  or  pushbutton set day (C) (e.g.: 1 = Monday).
7. Pushbutton .

#### 12.1.3.3. Weekly programme setting





















The weekly programming consists in the assignment of two programmes (P1, P2) to each (1-7) weekday, for which temperature level (L, H) and filtering process start and stop time is set.

During functioning of these programmes the filtration pump  and  heater are active, keeping the set water temperature level.

When P is selected as the day and appropriate programmes (P1, P2) are entered, all P1, P2 parameters will be automatically saved for days 1 to 5.





When the SPA bath user does not want a program (P1, P2) to start filtration pump and heater, programme start and stop hour should be set to 0. Then the programme will not be activated.

This function is selected with pushbutton .

1. Push pushbutton and hold  it over 3 seconds, P1 programme for the current day will be ON.
  2. With  or  pushbutton select day (C) (1-7 or P).
  3. Pushbutton .
  4. With  or  pushbutton select level (B) (L or H).
  5. Pushbutton .
  6. With  or  pushbutton select programme (A) start hour.
  7. Pushbutton .
  8. With  or  pushbutton select programme (B) start minute.
  9. Pushbutton .
  10. With  or  pushbutton select programme (A) termination hour.
  11. Pushbutton .
  12. With  or  pushbutton select programme (B) termination minute.
  13. With pushbutton  go to P2 programme for the selected day and act as above to modify parameters.
- After parameters modification push pushbutton , to save changes and quit programming mode.







#### 12.1.3.4. Heater cooling time setting

The function is selected with pushbutton . Setting can be changed between 0 and 50 minutes at any moment.

1. Push pushbutton and hold  it over 3 seconds.
2. With  or  pushbutton set minutes for each 10 minutes beginning from 10 minutes (0 to 50).
3. Pushbutton .

#### 12.1.3.5. Manual control

The function is selected with pushbutton . The following operations can be made:

1.   Pressing pushbutton  once activates the filtration pump.
2.  Pressing pushbutton  again activates the heater.
3. Pressing pushbutton , cancels all functions previously programmed.

#### 12.1.4. Control system operation





The control system automatically controls the filtration pump operation in two cycles saved for one week period, with regard to water temperature and level simultaneously.

If float sensor does not confirm the appropriate tank water level at the moment when the SPA bath power supply is ON, automatic bath filling solenoid valve activates and red diode is lit to show that the function is active .

When tank water level decreases (float sensor signals water level decrease), solenoid valve of automatic filling activates and red diode of automatic filling function blinks. .

If programmes saved in the memory have the same filtration start hour, the programme set for higher temperature is always activated.

#### 12.1.5. Temperature calibration procedure

1. Switch the equipment OFF.
  2. Holding and pushbuttons switches  and  the equipment ON. Release pushbuttons after signal is heard, display shows 00 °C.
  3. Pushbuttons  and  enable determination of difference between temperature displayed and real. If e.g. display shows 37°C and the real temperature is 25°C, select 12.
  4. Confirm the selection pressing pushbutton .
  5. Switch the equipment OFF.
- Proper temperature will be reached 5 seconds after the equipment is connected.

## 13. ACRYLIC COATING MAINTENANCE

The following precautions concerning the SPA bath cleaning and maintenance should be considered:

- Abrasive and aggressive products cannot be used for the SPA bath cleaning. They can destroy the coating.
- If the SPA surface is shining, removing of possible scratches is possible. Use wet abrasive paper of 800 grade then, to restore initial shine, use solvent-free polishing agent like that used for car body lacquering.
- Do not use alcohol nor other alcohol-based product to clean plastic components like electronic panel. To remove calcium remains use strongly diluted vinegar (acetic acid). Do not use store-bought chemicals.

## 14. DISINFECTION

Disinfection process in the SPA is UV lamp based. UV lamp is used during filtration.

Additionally, the bath is equipped with a START SET for pH correction and disinfection with active oxygen, as described in Part 15.

A special UV lamp generates UV-C radiation with a wavelength of 253,7 nm, which neutralizes bacteria, viruses and other primitive organisms, preventing their reproduction at the same time.

The benefits of UV-C radiation:

- ensures fresh, clean and clear water
- disinfects water safely and efficiently
- keeps the formation of mold, bacteria and algae under control
- reduces the use of chlorine and other chemicals by up to 80%
- prevents the smell of chlorine as well as skin and eye irritation (including eye redness)
- is more environmentally-friendly than traditional methods



**UV lamp work only during filtration.**

## 15. MAINTENANCE OF WATER

In order to maintain perfect hygienic and aesthetic conditions of water, use of disinfection and water cleaning products specifically designed for the SPA baths is recommended.



**Before the first bath and always once in 2 weeks, please check the water pH with the enclosed Dinofresh/pH Tester!!!**

### pH tester: pH value measurement

- The test container must be rinsed and filled (up to the 10 ml mark) with pool water.
- Put one PHENOLRED tablet to the container filled with water and close the container with a plug.
- Shake the container until the tablet has dissolved completely.
- Compare the colour of the solution with the colours in the column on the left side to read the pH value of the tested water sample.
- The ideal value is 7.2 – 7.6

### Dinofresh contents measurement

- The test container must be rinsed and filled (up to the 10 ml mark) with tested water.
- Put one DPD no. 4 tablet to the container filled with water and close the container with a plug.
- Shake the container until the tablet has dissolved completely.
- Compare the colour of the solution with the colours in the column on the right side to read the Dinofresh value of the tested water sample.
- The ideal value is: 3,0 – 8,0 mg/l.



### Important instructions:

- Touching tablets with fingers may cause distortion of test results.
- Reading of results must take place immediately after the tablet has dissolved in water.
- Rinse the test container and the plug carefully after each measurement.

In other case distortion of results may take place.

- All pH values below 6,8 cause yellow water colouring.
- All pH values above 8,2 cause red water colouring.



**CAUTION: The tablet reagents are provided for the purpose of the above described chemical analyses and should not be used for any other purposes. The tablet reagents cannot be handled for children.**

### 1. Dinominus – pH decreasing granules

Dosage: to lower the pH value by 0.1 add approximately 10g per 1 m<sup>3</sup> of water.

With the filtration pump on, pour the granules to the bath and spread evenly on the whole surface of the bath. Measurement should be taken immediately after the use of Dinominus.

Do not add near the skimmer.

### 2. Dinofresh (granules) – active oxygen granules for disinfection of water should be dozed to the skimmer.

Dosage: 25g per 1 m<sup>3</sup> – start up portion, subsequent portions of 5g or multiple amounts to maintain the 5-8 mg/l content of Dinofresh in water.

3. **Dinoclean S** – strong alkaline liquid agent for cleaning of the rim of the bath and to dissolve grease. Especially convenient for removal of greasy stains on ceramic surfaces and bath edges as well as for removal of lime stains.

**Dosage:** spread concentrated or dissolved (1:10) agent on dirty surfaces using a brush. Rinse thoroughly after a short period of time. Do not let the agent dry before rinsing.

- It is recommended to switch on the water filtrating pump for at least 5-6 hours per day, i.e. one hour before the intended use of the bath and a few hours after use, then for 3 subsequent hours of the same day at another hour. The filtrating pump must be in constant operation to ensure the water is completely clean. Check every once in a while if there is hair and other waste to be removed from the pump chamber.



**It is a natural phenomenon that in SPA baths the pH value of water tends to increase. However, very rarely the pH value decrease can be observed. It is then recommended to use Dinoplus granules, which can be ordered through the showroom of the SPA baths manufacturer.**



# TERMS OF GUARANTEE

1. The manufacturer of hydromassage baths, ROCA POOL-SPA Spółka z o.o. with its seat in Gliwice, ul. Wyczółkowskiego 20, hereby grants a 24-month guarantee for the SPA bath and ensures a post-guarantee service.
2. The manufacturer grants a 7-year guarantee for colour and polish of the acrylic surface, subject to compliance with the maintenance requirements as specified in this operation manual.
3. Defects and damages of the product identified within the guarantee period and not caused by the user will be repaired free of charge within 14 days from the date of notification by the Client. All repairs are conducted at Client's site.
4. All defects and damages of the product should be reported to the Seller. In case contacting the Seller is not possible, please notify the Service Department of ROCA POOL-SPA in Gryfice in writing.
5. The Client shall lose the guarantee in case of:
  - mechanical damages of the fixtures
  - mechanical damages of the surface of the product
  - repairs and modifications of the electronic control system carried out by the Client
  - installation of casing in a manner which does not allow for proper ventilation and free access to all equipment installed under the bath
  - installation of other fixtures on the bath tube and frame
  - use of improper cleaning agents, not in compliance with the recommendations of the instruction manual
  - use of water which is not in compliance with the required parameters as per the Regulation of the Minister of Health and Social Security of May 4th, 1990, Journal of Laws No. 35.
6. The Guarantee Card is not valid unless the Seller confirms the sale with his signature, stamp and date on the Guarantee Card included at the end of the manual, on the date of the purchase of the product.
7. The guarantee is valid subject to installation of the unit by a technician with a licence for electrical works (this should be confirmed on the Guarantee Card).
8. The manufacturer will not reimburse the costs of any damages to wall and floor tiles caused directly in result of the necessary repairs as part of guarantee service works.
9. This Guarantee is valid on the territory of the Republic of Poland.

ROCA POOL-SPA Sp. z o.o.  
ul. Wyczółkowskiego 20,  
44-109 Gliwice  
tel. + 48 91 38 777 00  
www.poolspa.pl,



# TECHNICAL PRODUCT SHEET

 MODEL

[Redacted]

 FACTORY NUMBER

[Redacted]

 DATE OF PRODUCTION AND TESTING

[Redacted]

 NOMINAL POWER REQUIREMENTS

[Redacted]

 FUSING REQUIREMENTS

[Redacted]

 VOLTAGE / FREQUENCY

3 x 380V/50 Hz

 THERMAL PROTECTION

F

 QUALITY CONTROL

[Redacted]



ROCA POOL-SPA Sp. z o.o.  
ul. Wyczółkowskiego 20,  
44-109 Gliwice  
tel. + 48 91 38 777 00  
[www.poolspace.pl](http://www.poolspace.pl),

ROCA POOL-SPA company has the policy of constant improvement of products and reserves the right to introduce changes to the specification and colours without a prior notification. However, ROCA POOL-SPA makes all efforts to ensure that the specifications are updated on the date of publication.



29.01.2018  
PI3000182