

GB ASSEMBLY INSTRUCTIONS

BUL ИНСТРУКЦИЯТА ЗА МОНТАЖ

CZ NÁVOD K MONTÁŽI

D MONTAGEANLEITUNG

E INSTRUCCIONES DE MONTAJE

EST MONTAAŽI INSTRUKTSIOON

F INSTRUCTIONS DE MONTAGE

H SZERELÉSI UTASÍTÁST

HR UPUTE ZA MONTAŽU

I ISTRUZIONI DI MONTAGGIO

LT MONTAVIMO INSTRUKCIJA

LV MONTĀŽAS INSTRUKCIJA

NL MONTAGE INSTRUCTIES

PL INSTRUKCJA MONTAŻU

RO INTRUCȚIUNI DE MONTAJ

RUS ИНСТРУКЦИЯ ПО МОНТАЖУ

S MONTERINGSANVISNINGAR

SK NÁVOD NA MONTÁŽ

SLO NAVODILA ZA MONTAŽO

UA ІНСТРУКЦІЯ ЗА МОНТАЖУ

# MISSISSIPI

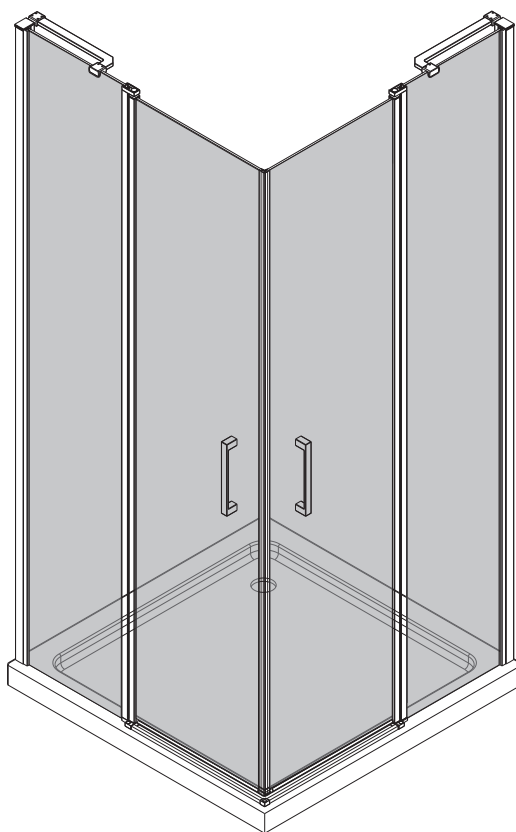

GB Please retain the assembly instructions in the event that you will have to order spare parts.

BUL Моля запазете инструкцията за монтаж, в случай, че възникне нужда да поръчате резервни части.

CZ Prosíme, aby jste uchovali Montážní návod pro případ nutnosti objednat náhradní součástky.

D Bitte bewahren Sie die Montageanleitung auf für den Fall, dass Ersatzteile bestellt werden müssen.

E Conserve las instrucciones de montaje por si tiene que pedir recambios.

EST Hoidke koostamisjuhend hilisemaks kasutamiseks (nt varuosade tellimiseks) alles.

F Veuillez conserver cette instruction de montage pour le cas où il serait nécessaire de commander des pièces ultérieurement.

H Kérjük, őrizze meg a beépítési utasítáha cseré al átésztt ke l rendelnie, st arra az esetre.

HR Molimo čuvati instrukciju montaže u slučaju potrebe narudžbe rezervnih dijelova.

I Vi preghiamo di conservare le istruzioni di montaggio per poter eventualmente ordinare parti di ricambio.

LT Prašome išsaugoti montavimo instrukciją tam atvejui, jei prireiktų užsakyti atsargines detales.

LV Lūdzu, saglabāt lietošanas/montāžas instrukciju gadījumā, ja rastos nepieciešamība pasūtīt rezerves daļas.

NL Bewaar de montagehandleiding voor het geval u vervangingsonderdelen moet bestellen.

PL Prosimy zachować instrukcję montażu na wypadek konieczności zamówienia części zamiennych

RO Vă rugăm păstrați instrucțiunile de montaj pentru eventualitatea comandării unor piese de schimb.

RUS Сохраните инструкцию по монтажу на случай необходимости заказа запасных частей.

















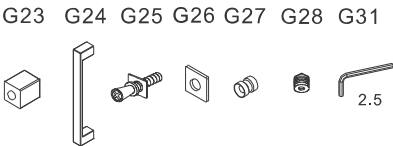

S Spara monteringsanvisningarna. Du kan behöva de senare när du beställer reservdelar.

SK Návod na montáž si prosím ponechajte pre prípad objednávania náhradných dielov.

SLO Prosimo, da shranite navodila za montažo za primer, da boste hoteli naročiti rezervne dele.

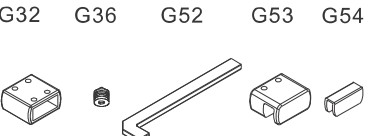
UA Збережіть інструкцію з монтажу на випадок необхідності замовлення запасних частин.

140716

№ • № • čís. • Nr. • № • arv • № • Sorszám • № • № • Nr. • Nr. • Nr. • Nr. • Nr. • № • Nr. • C. • Št. • Nr	Description • Символ • Označení • Bezeichnung • Especificación • Kirjeldus • Description • Megjelölés • Oznaka • Denominazione • Pavadinimas • Apzīmējums • Benaming • Označenie • Symbol • Название • Beskrivning • Popis • Opis • Означення	Pieces • Брой • Kusú • Stück • Cantidad • Huk • Quantité • Darabszám • Komaci • Pezzi • Vienetai • Gab. • Stucks • Szt. • Bucáji • Колчество • Stuck • Ks. • Kosov • Штук	1 order [pcs] Поръчка [бр.] Objednávám [ks.] Bestellte Stückzahl Hacer un pedido [unidades] Ma tellin [tk] Je commande [pieces] Megrendelek [db] Naručujem [kom.] Ordino [pezzi] Užsisakau [vnt.] Pasutu [gab.] Ik bestel [stuks] Zamawiam [szt.] Command [buc.] Заказ на [шт.] Jag beställer [st.] Objednávám [ks.] Narogam [kosov] Zamовлення на [шт.]
G10. G11. G12. G13.		1 1 1 1	
G14.		2	
G15.		2	
G16.		12	
G17.	 ST4x30	12	
G18.		8	
G19.	 ST4x10	8	
G23. G24. G25. G26. G27. G28. G31.		4 2 4 8 4 4 1	
G39.		2	
G40. G41		1 1	
G45.	 ST3.5x30	4	
G46.		2	
G47. G48.		1 1	
G49.	 ST4x20	3	
G50.		3	
G32. G36. G52. G53. G54.		2 16 2 2 2	
G58.		1+1	
G59. G60.		1 1	
G61.		2	
G62.		1	

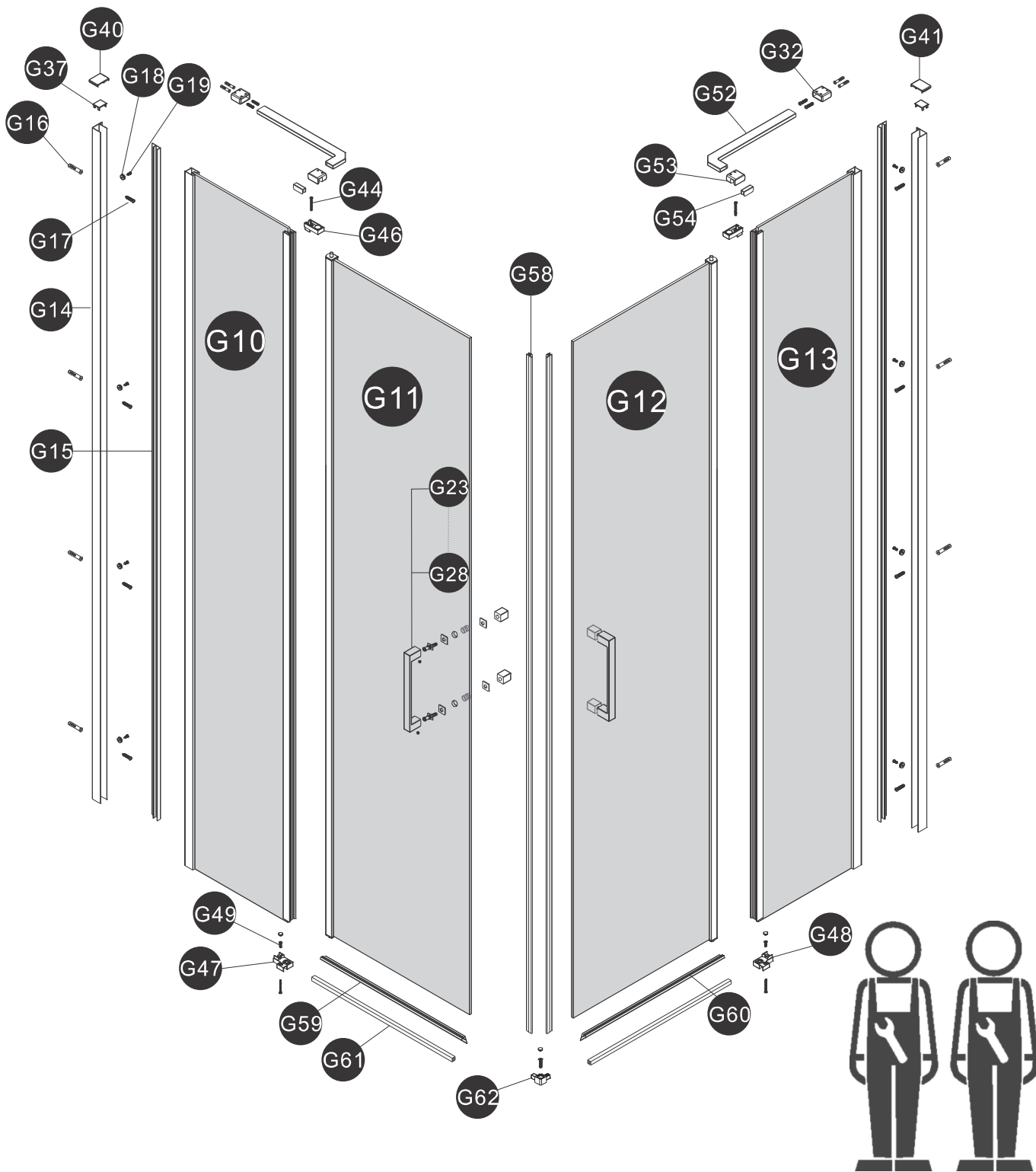
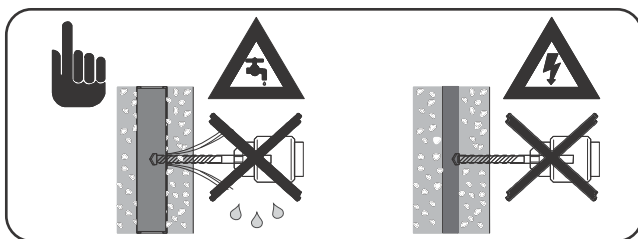
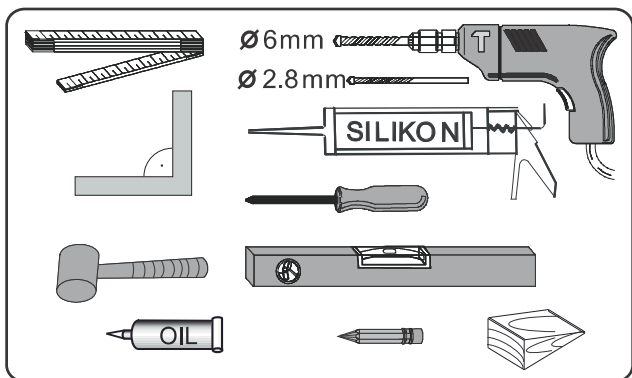

1.

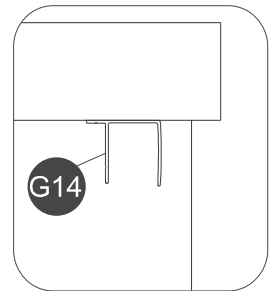
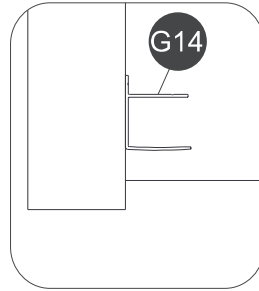
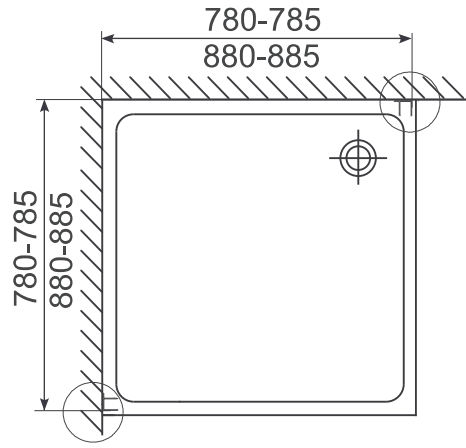
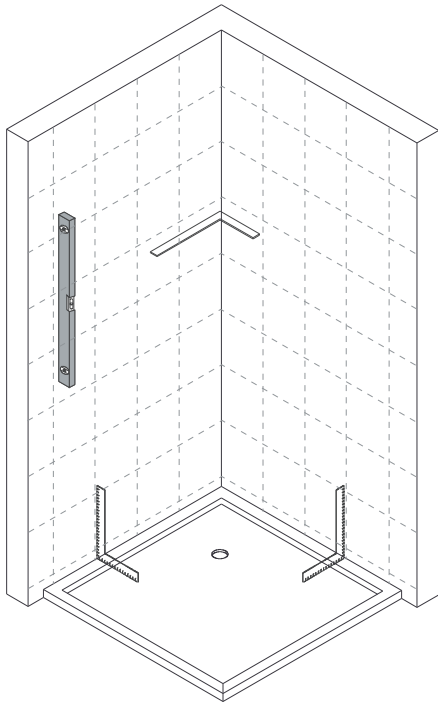

2.

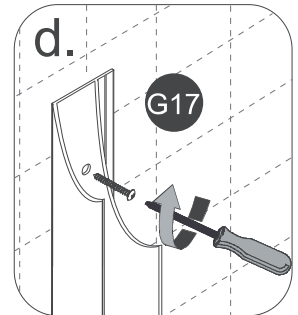
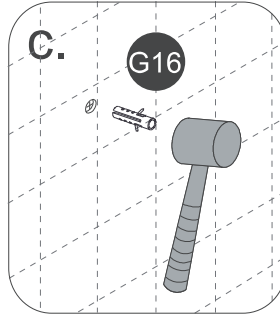
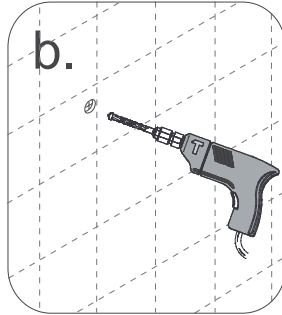
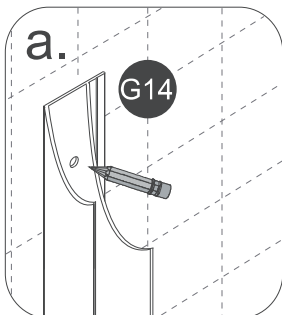
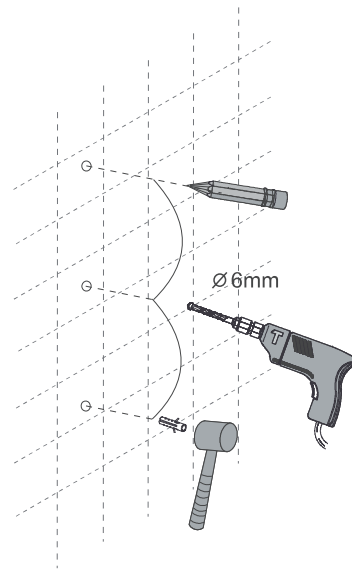
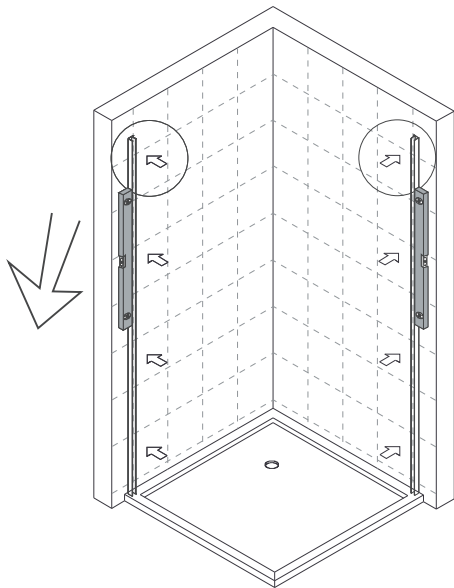

# 3.

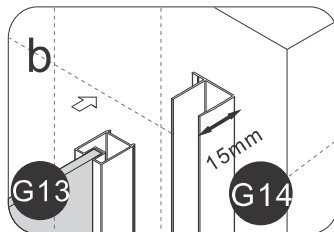
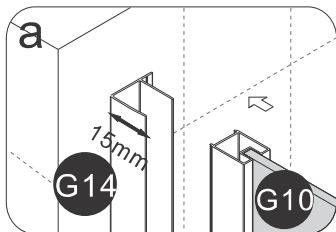
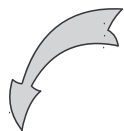
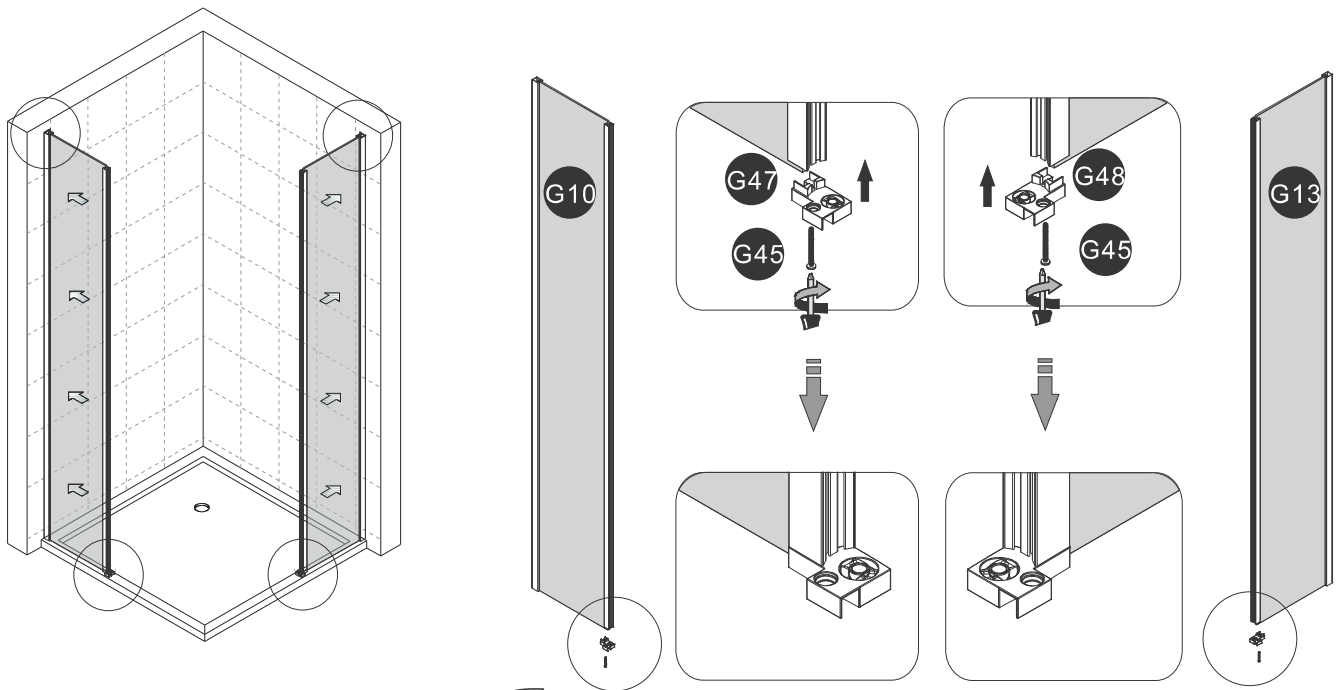

# 4.

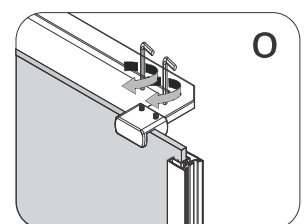
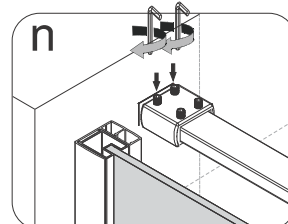
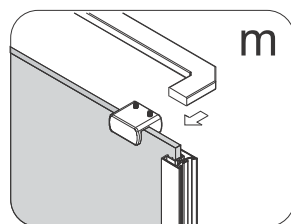
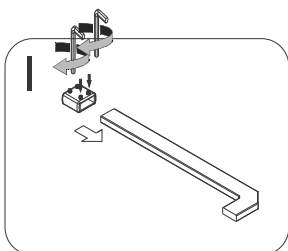
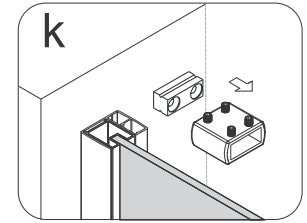
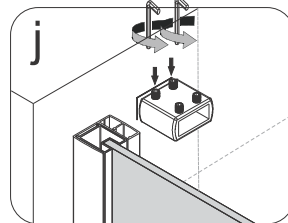
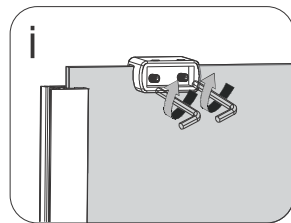
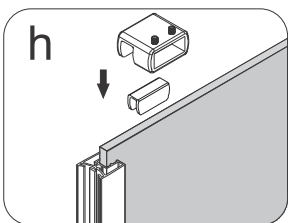
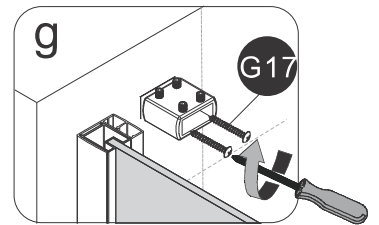
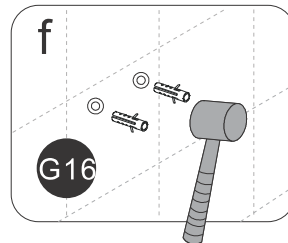
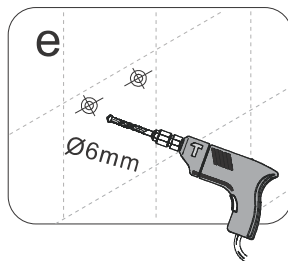
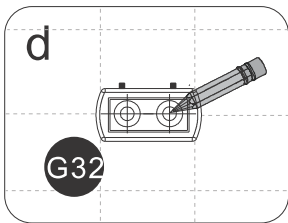
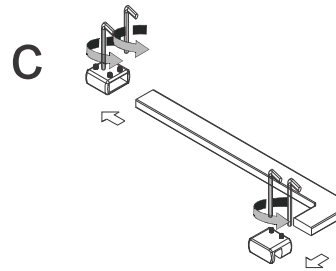
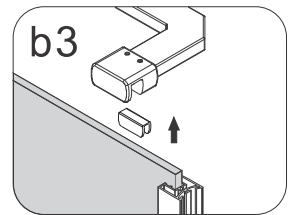
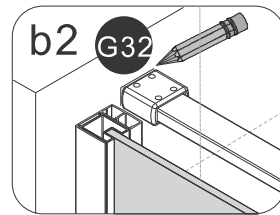
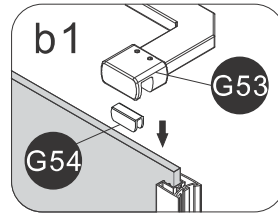
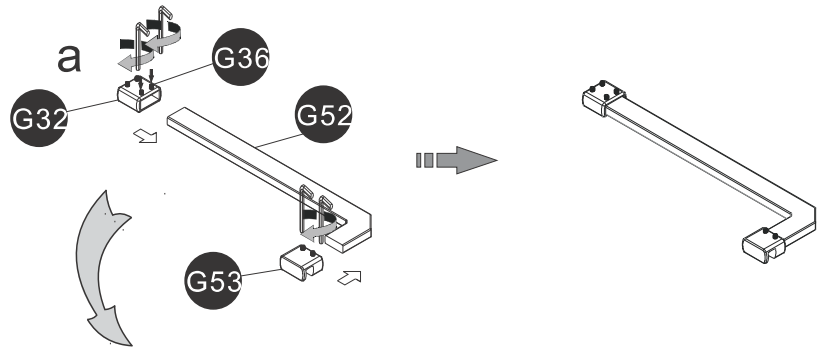
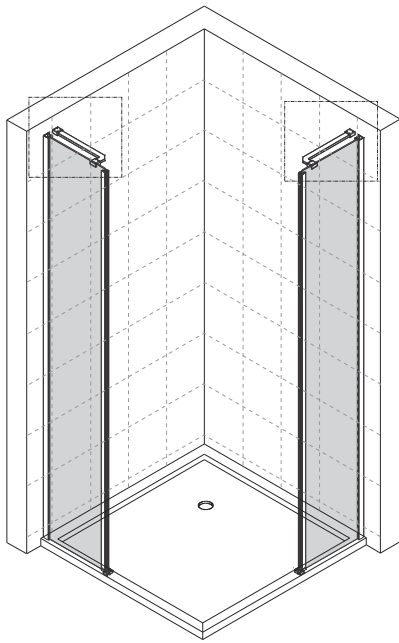

# 5.

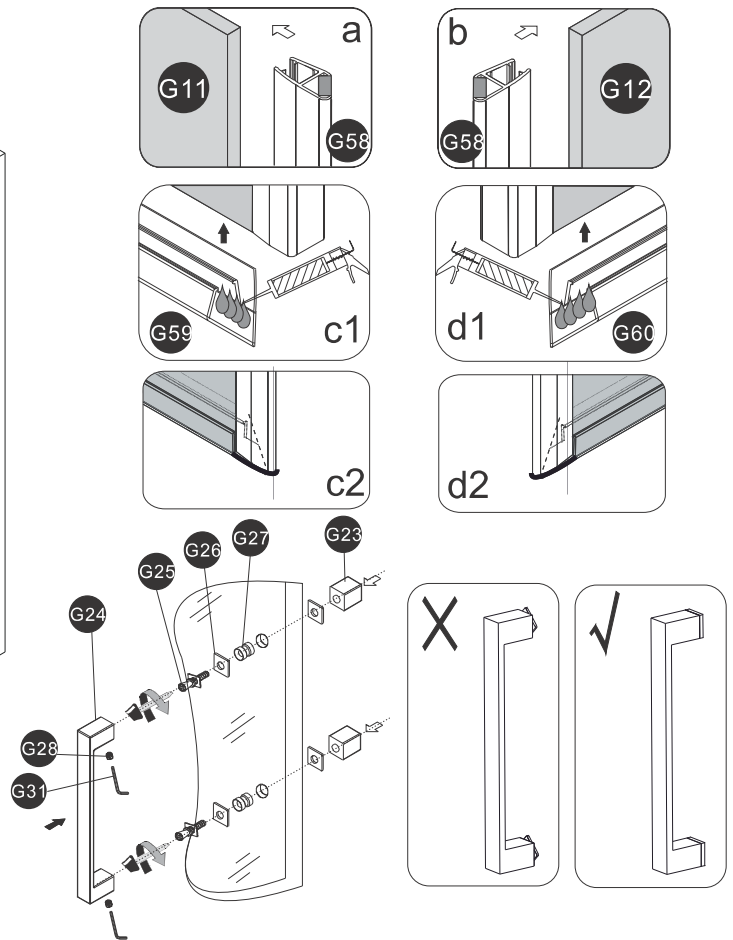
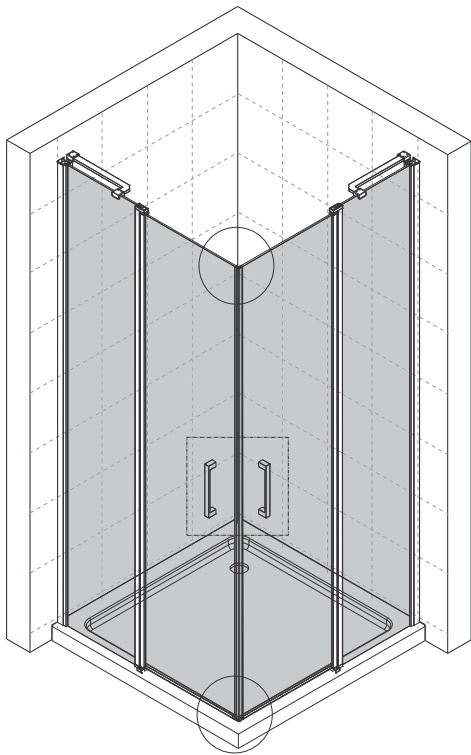

# 6.

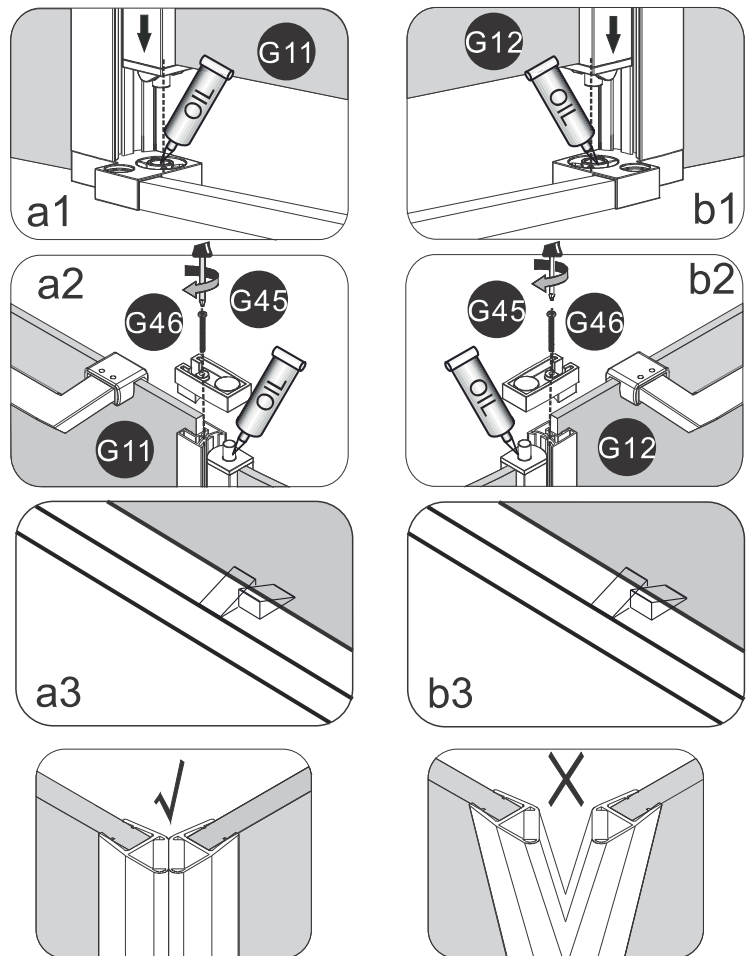
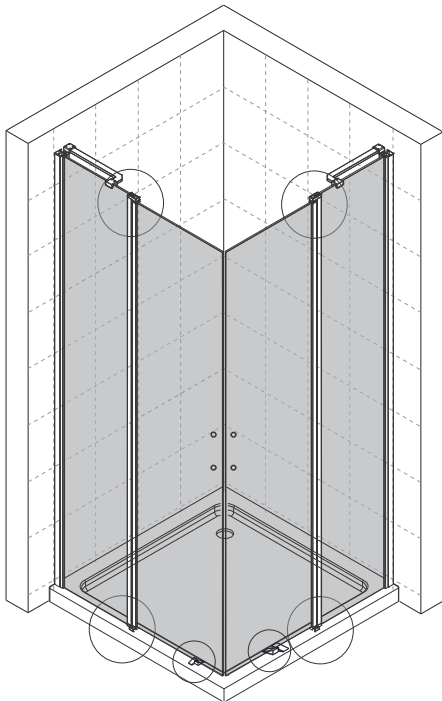

# 7.

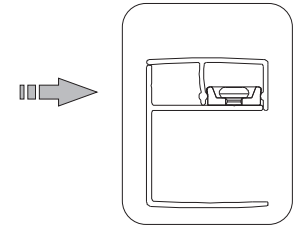
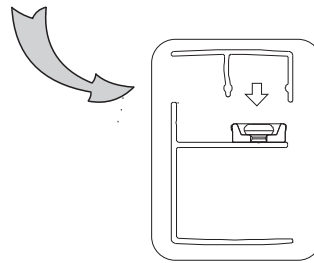
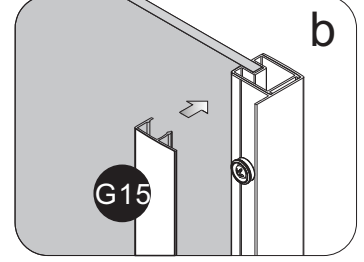
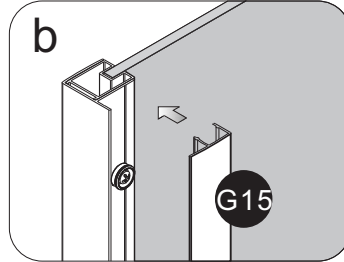
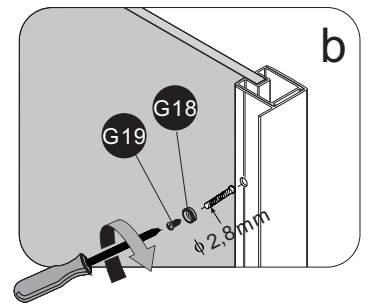
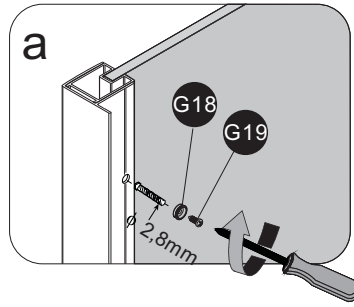
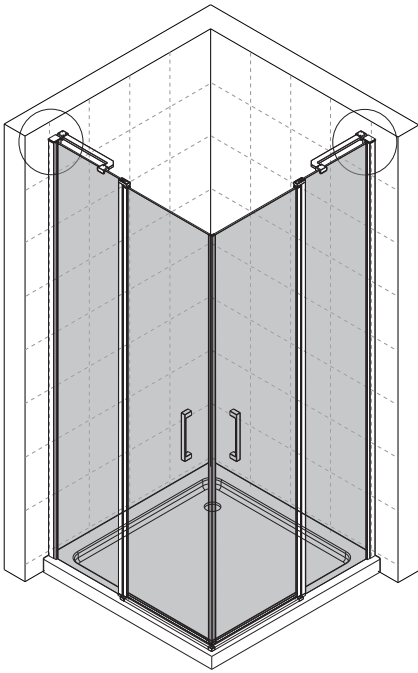

# 8.

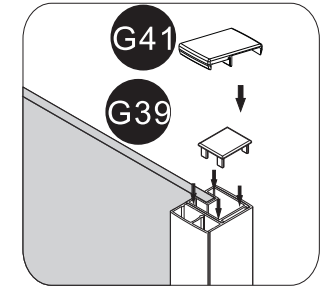
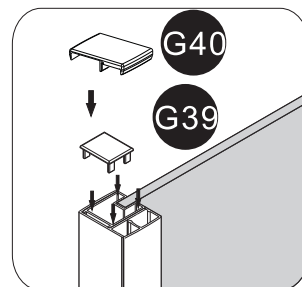
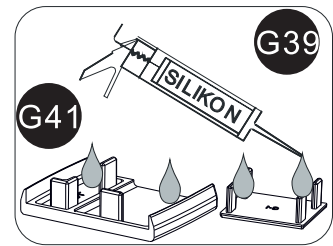
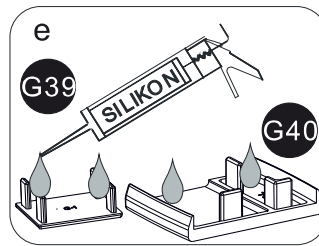
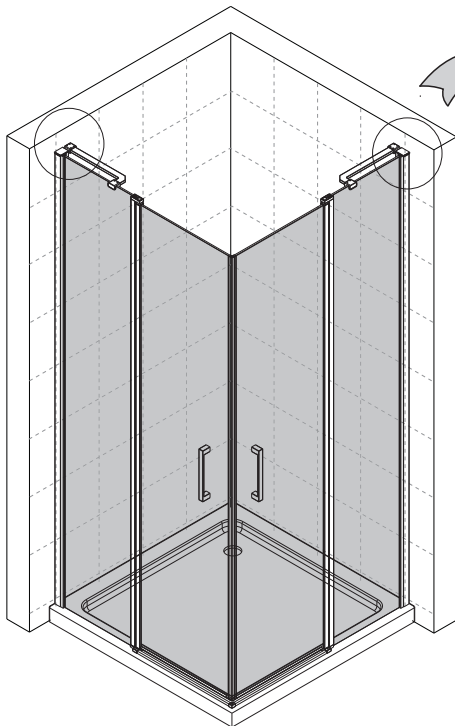



9.

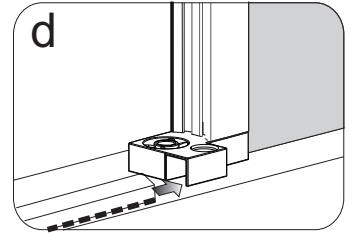
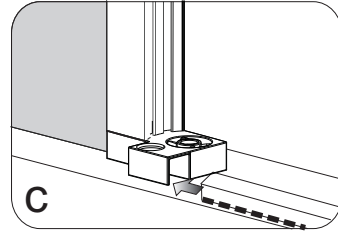
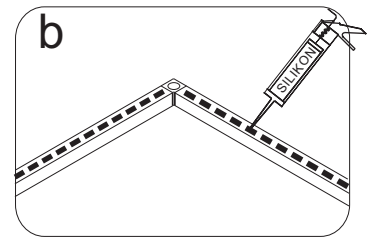
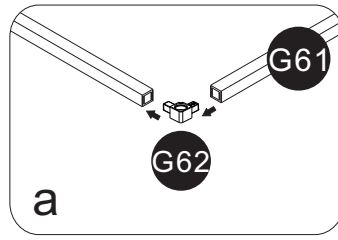
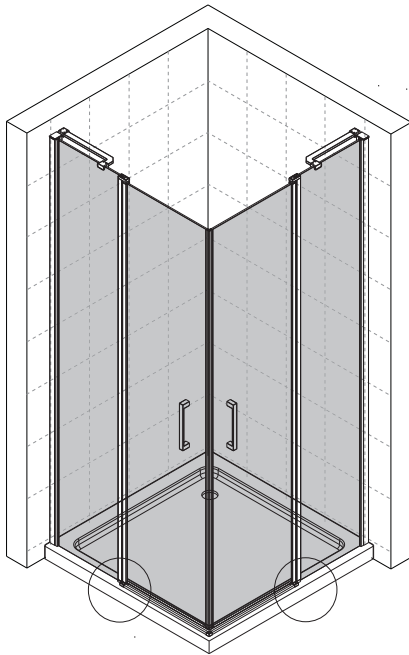

### OPTION 1

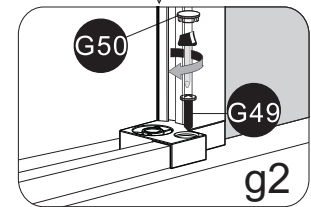
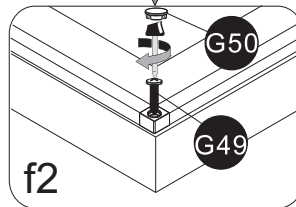
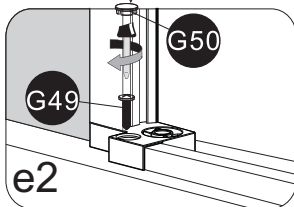
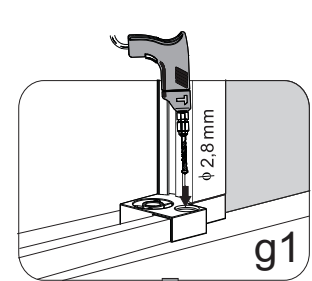
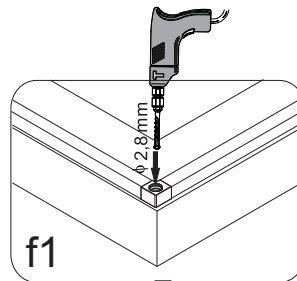
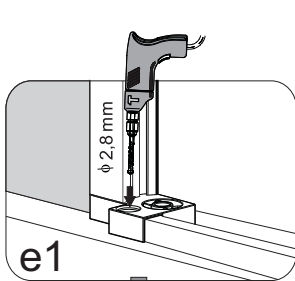

### OPTION 2

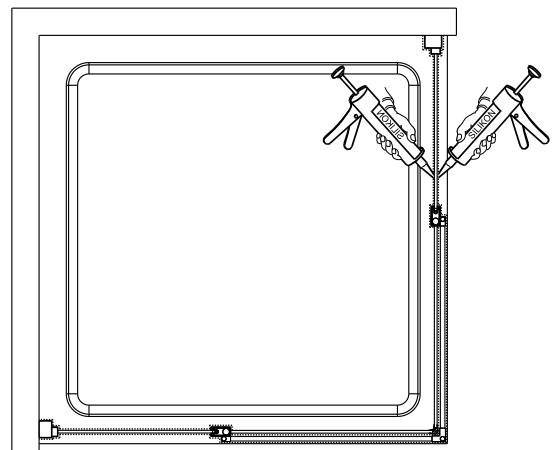
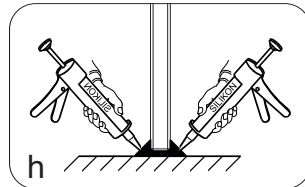
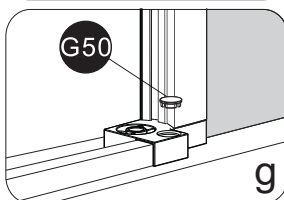
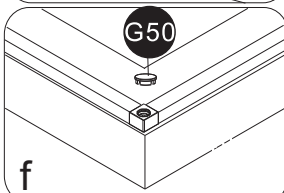
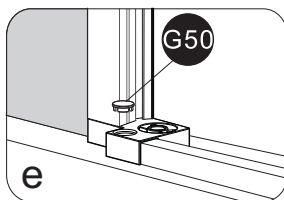

10.

