

(GB) ASSEMBLY INSTRUCTIONS

(BUL) ИНСТРУКЦИЯТА ЗА МОНТАЖ

(CZ) NÁVOD K MONTÁŽI

(D) MONTAGEANLEITUNG

(E) INSTRUCCIONES DE MONTAJE

(EST) MONTAAŽI INSTRUKTSIOON

(F) INSTRUCTIONS DE MONTAGE

(H) SZERELÉSI UTASÍTÁST

(HR) UPUTE ZA MONTAŽU

(I) ISTRUZIONI DI MONTAGGIO

(LT) MONTAVIMO INSTRUKCIJA

(LV) MONTĀŽAS INSTRUKCIJA

(NL) MONTAGE INSTRUCTIES

(PL) INSTRUKCJA MONTAŻU

(RO) INSTRUCȚIUNI DE MONTAJ

(RUS) ИНСТРУКЦИЯ ПО МОНТАЖУ

(S) MONTERINGSANVISNINGAR

(SK) NÁVOD NA MONTÁŽ

(SLO) NAVODILA ZA MONTAŽO

(UA) ІНСТРУКЦІЯ ЗА МОНТАЖУ

# ARKANSAS



(GB) Please retain the assembly instructions in the event that you will have to order spare parts.

(BUL) Моля запазете инструкцията за монтаж, в случай, че възникне нужда да поръчате резервни части.

(CZ) Prosíme, aby jste uchovali Montážní návod pro případ nutnosti objednat náhradní součástky.

(D) Bitte bewahren Sie die Montageanleitung auf für den Fall, dass Ersatzteile bestellt werden müssen.

(E) Conserve las instrucciones de montaje por si tiene que pedir recambios.

(EST) Hoidke koostamisjuhend hilisemaks kasutamiseks (nt varuosade tellimiseks) alles.

(F) Veuillez conserver cette instruction de montage pour le cas où il serait nécessaire de commander des pièces ultérieurement.

(H) Kérjük, őrizze meg a beépítési utasítáha cser al atrészt ke l rendelnie, st arra az esetre.

(HR) Molimo čuvati instrukciju montaže u slučaju potrebe narudžbe rezervnih dijelova.

(I) Vi preghiamo di conservare le istruzioni di montaggio per poter eventualmente ordinare parti di ricambio.

(LT) Prašome išsaugoti montavimo instrukciją tam atvejui, jei prireiktų užsakyti atsargines detales.

(LV) Lūdzu, saglabāt lietošanas/montāžas instrukciju gadījumā, ja rastos nepieciešamība pasūtīt rezerves daļas.

(NL) Bewaar de montagehandleiding voor het geval u vervangingsonderdelen moet bestellen.

(PL) Prosimy zachować instrukcję montaży na wypadek konieczności zamówienia części zamiennych

(RO) Vă rugăm păstrați instrucțiunile de montaj pentru eventualitatea comandării unor piese de schimb.

(RUS) Сохраните инструкцию по монтажу на случай необходимости заказа запасных частей.











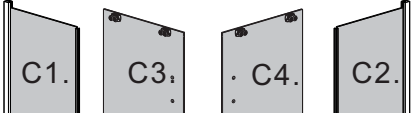

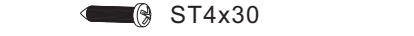
(S) Spara monteringsanvisningarna. Du kan behöva de senare när du beställer reservdelar.

(SK) Návod na montáž si prosím ponechajte pre prípad objednávania náhradných dielov.

(SLO) Prosimo, da shranite navodila za montažo za primer, da boste hoteli naročiti rezervne dele.

(UA) Збережіть інструкцію з монтажу на випадок необхідності замовлення запасних частин.

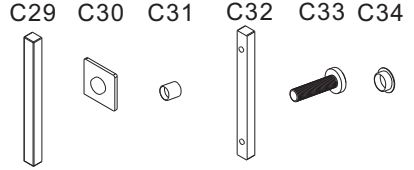
281116

№ • Nr. • čís. • Nr. • № • arv • № • Sorszám • № • № • Nr. • Nr. • Nr. • Nr. • Nr. • № • Nr. • C. • St. • Nr	Description • Символ • Označení • Bezeichnung • Especificación • Kirjeldus • Description • Megjelölés • Oznaka • Denominazione • Pavadinimas • Apzīmējums • Benaming • Oznaczenie • Simbol • Название • Beskrivning • Popis • Opis • Означення	Pieces • Брой • Kúsi • Stück • Cantidad • Huk • Quantité • Darabszám • Komadi • Pezji • Vienetai • Gab. • Stücks • Szt. • Bucăți • Колчество • Styc • Ks. • Kosov • Штук	I order [pcs] Поръчка (бр.) Objednávám [ks.] Bestellte Stückzahl Hacer un pedido [unidades] Ma tellin [tk] Je commande [pcs] Megrendelek [db] Naručujem [kom.] Ordino [pezji] Užsisakau [vnt.] Pasūtu [gab.] Ik bestel [stuks] Zamawiam [szt.] Comand [buc.] Заказ на [шт.] Jag beställer [st.] Objednávám [ks.] Naročam [kosov] Замовлення на [шт.]
C1. C3. C4. C2.		1 1 1 1	
C9. C10.		2 2	
C11. C12.		2 2	
C14.		24	
C15.		8	
C16.		8	
C17.		8	
C19. C20.		2 1+1	
C21. C22.		1 1	
C23.		2	
C25. C26.		2 2	
C28.		4	
C29. C30. C31. C32. C33. C34.		2 8 4 2 4 4	
C35.		1	

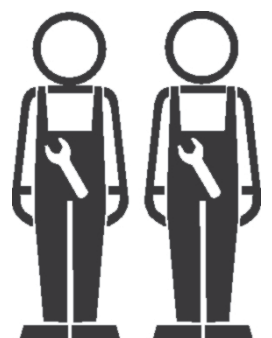
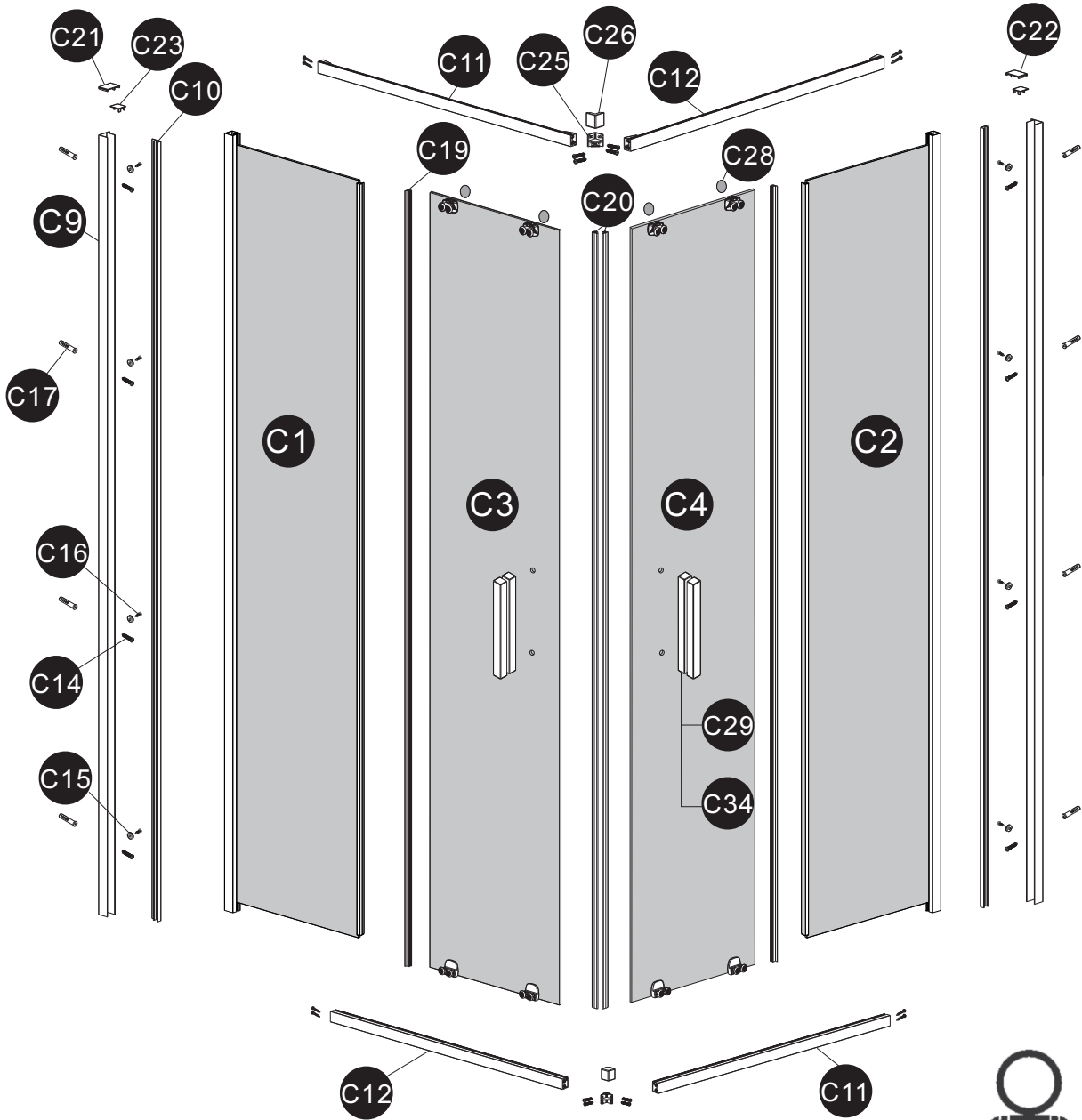
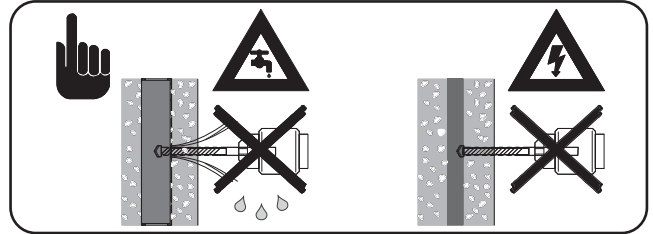
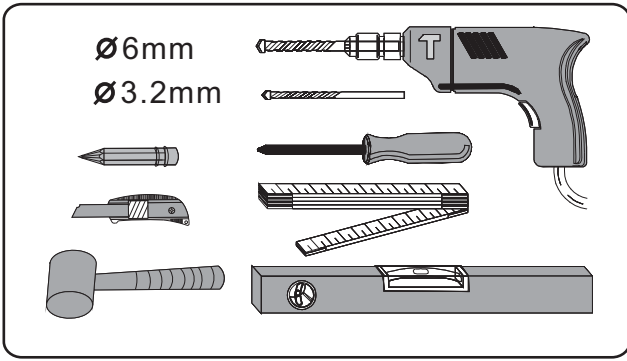

1.

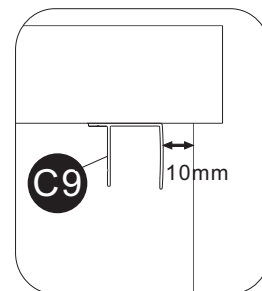
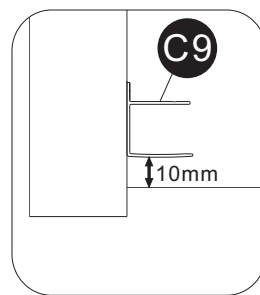
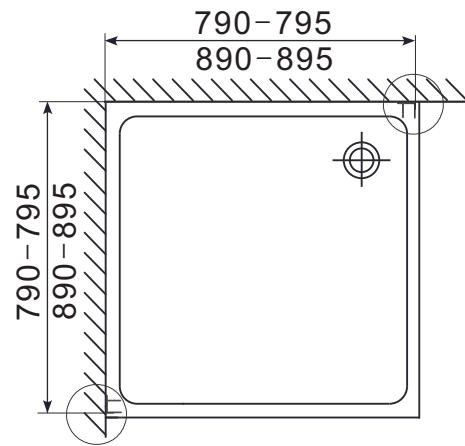
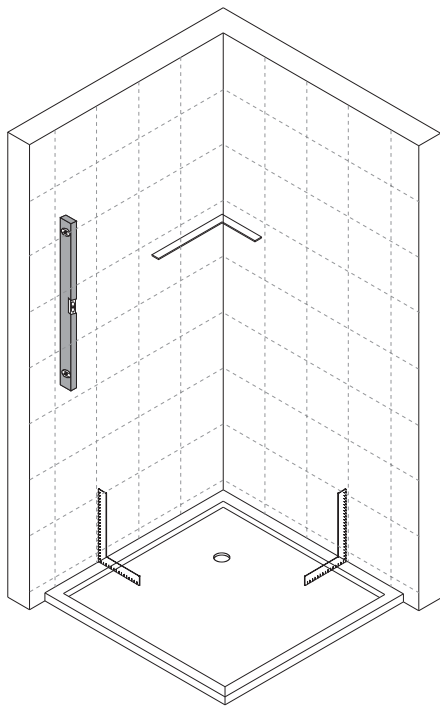

2.

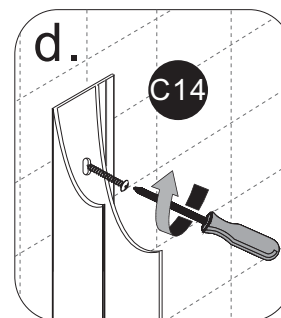
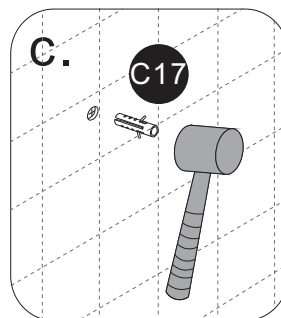
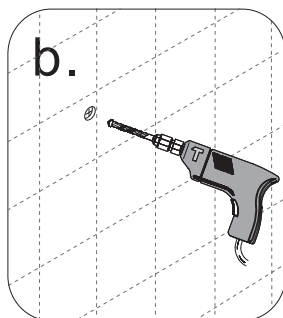
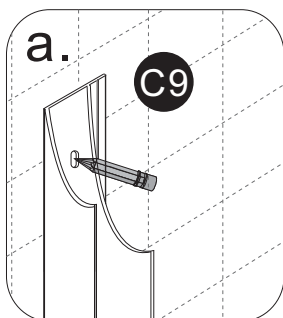
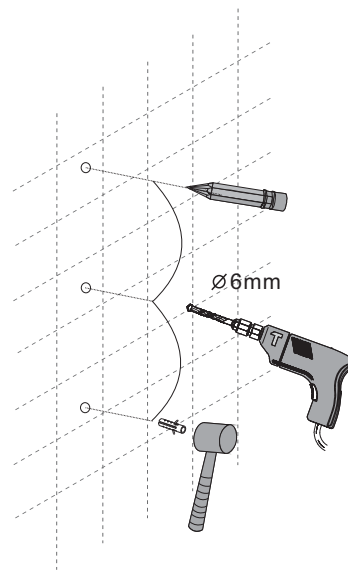
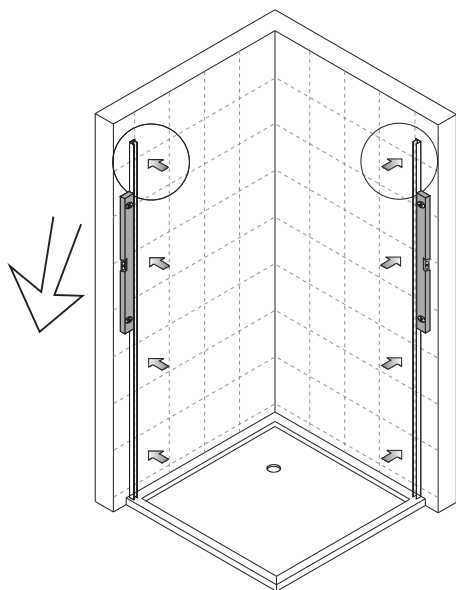

# 3.

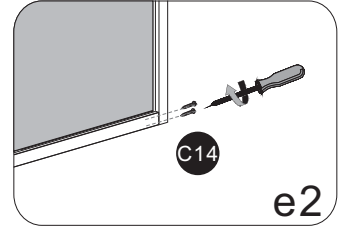
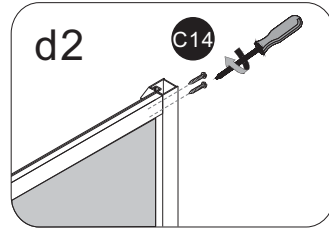
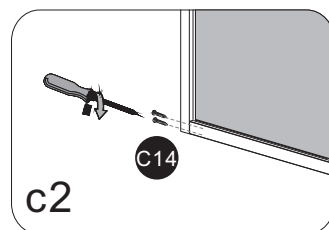
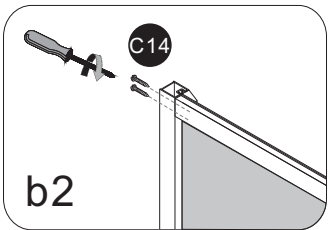
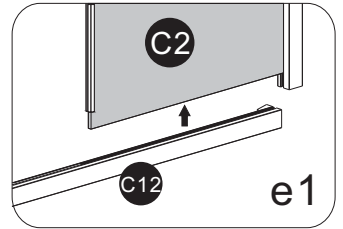
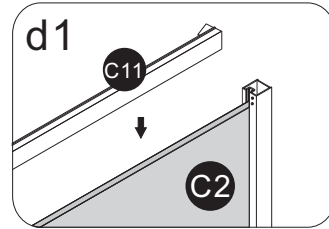
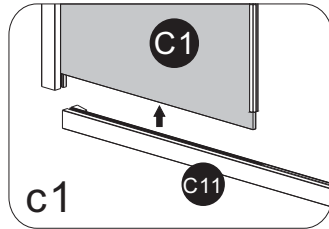
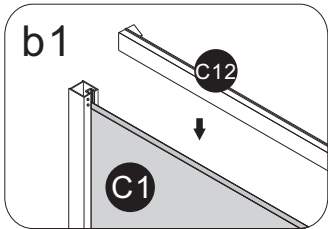
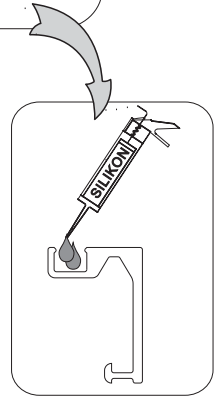
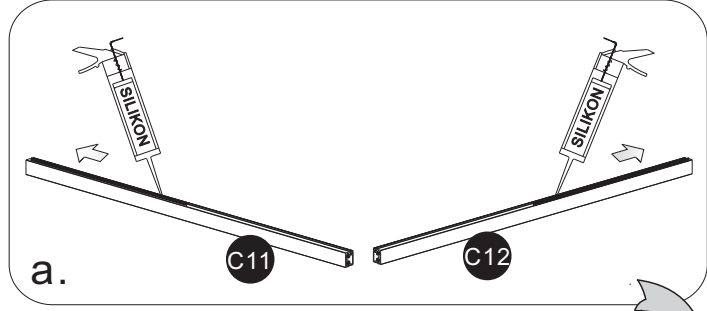
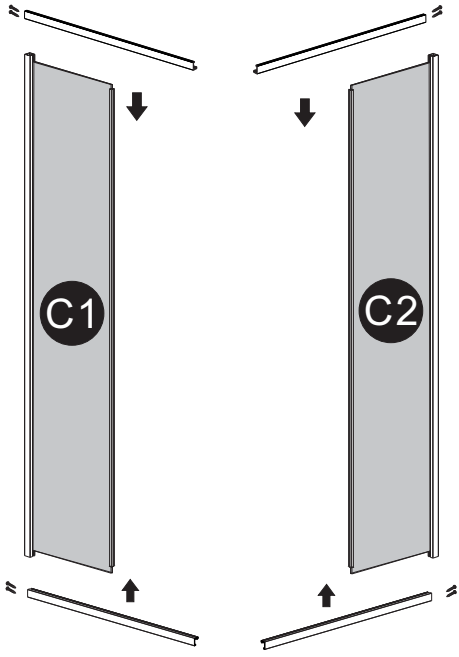

4.

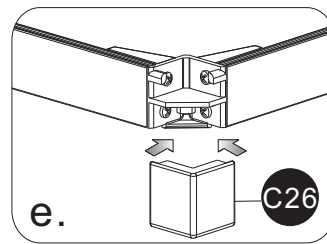
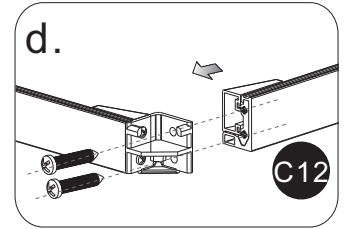
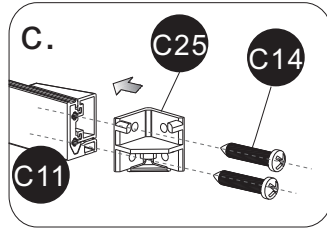
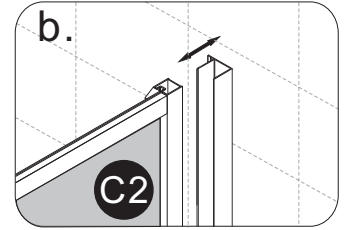
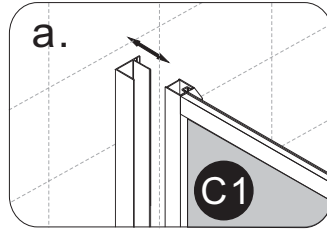
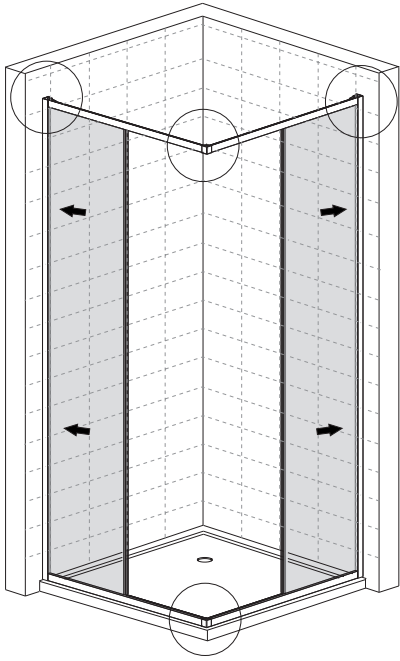

5.

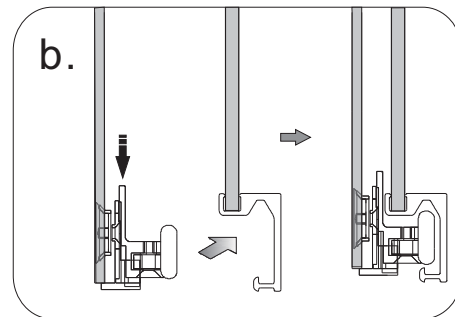
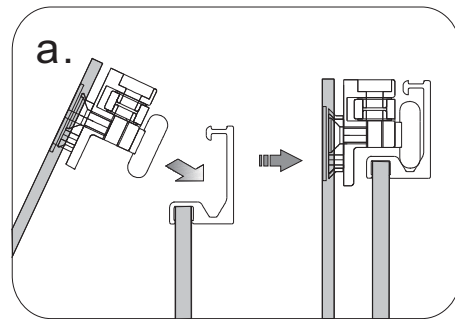
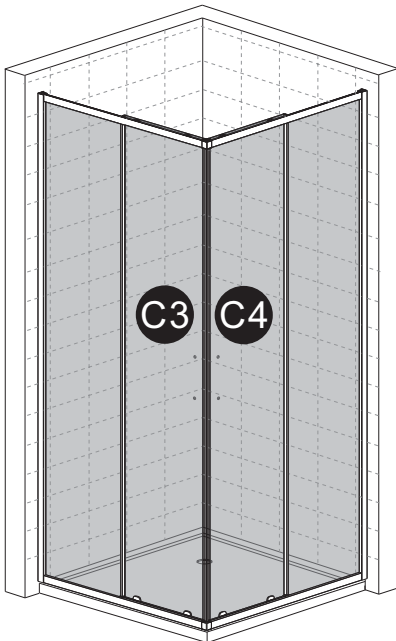

6.

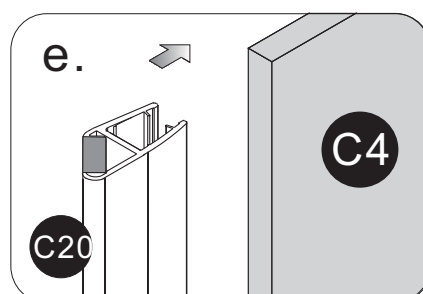
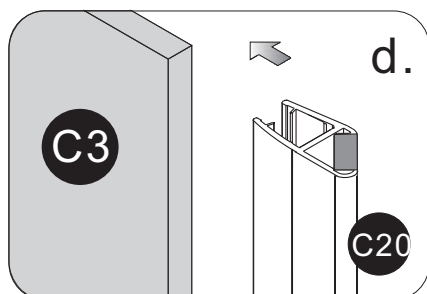
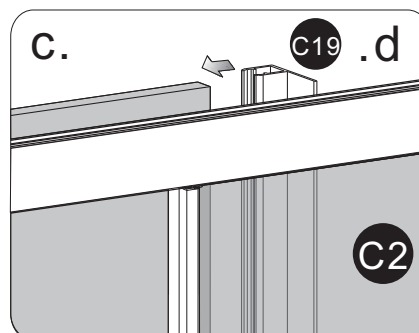
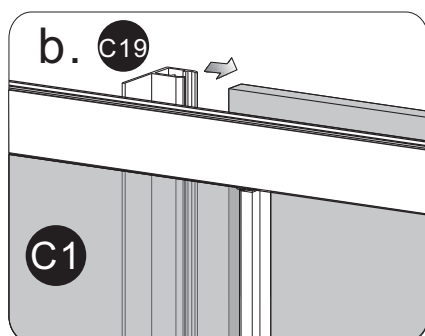
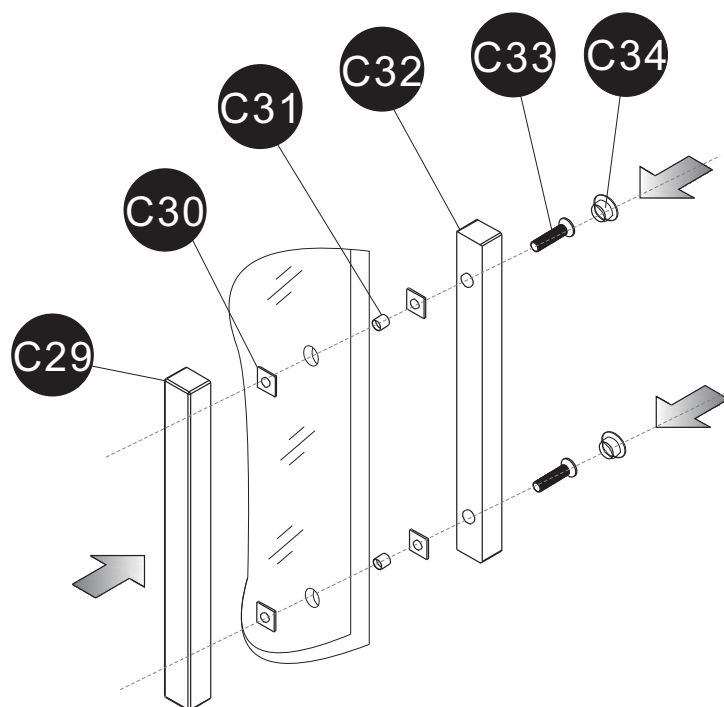
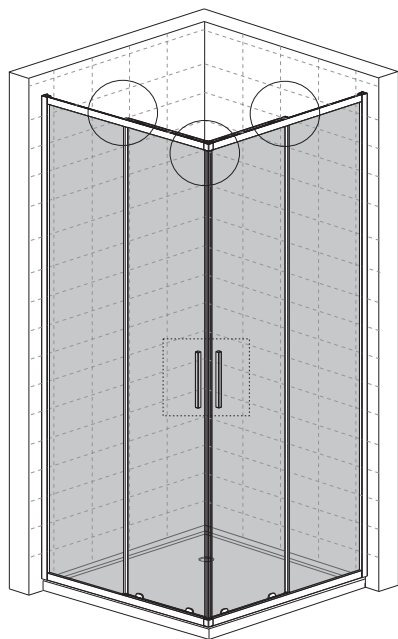

# 7.

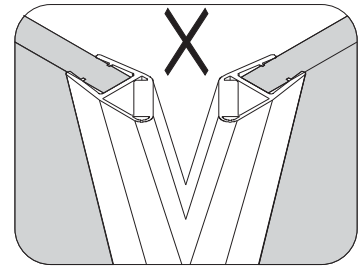
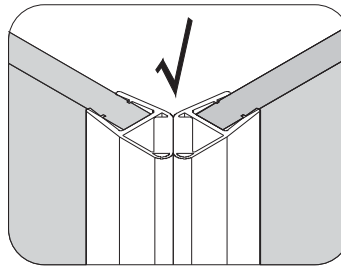
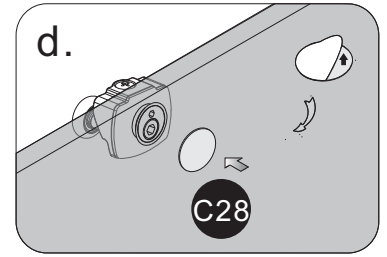
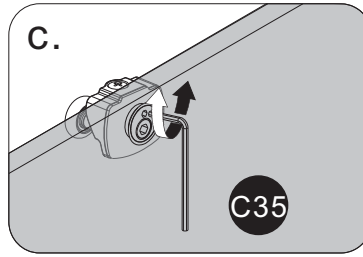
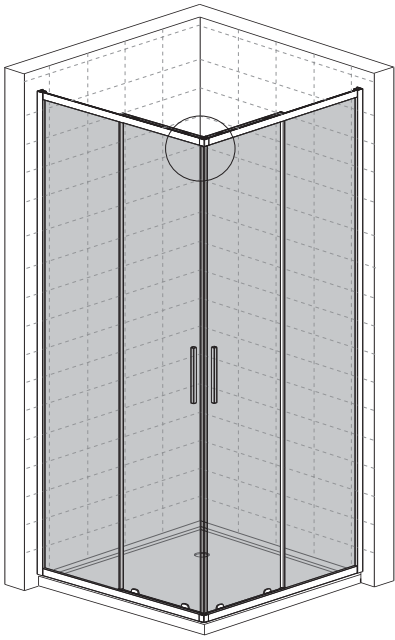

# 8.

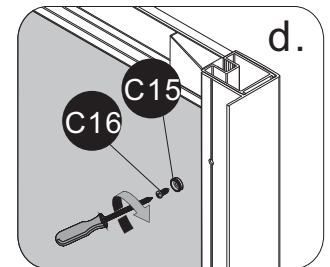
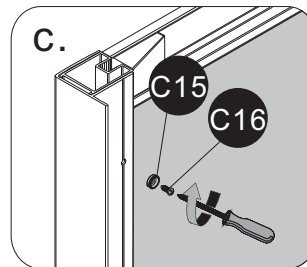
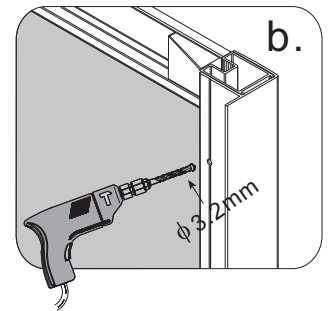
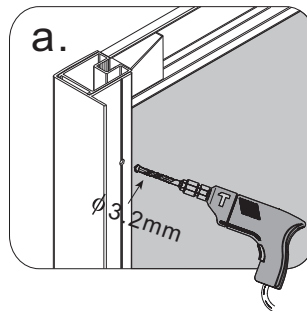
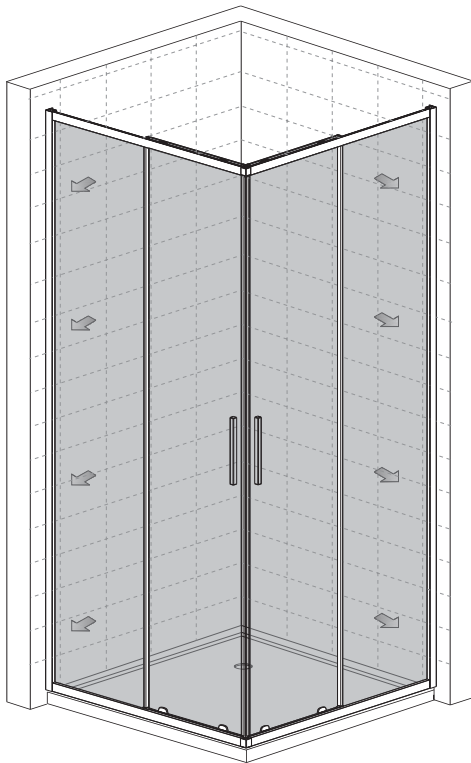



# 9.

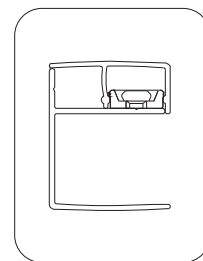
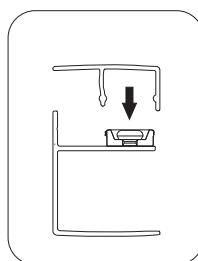
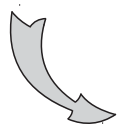
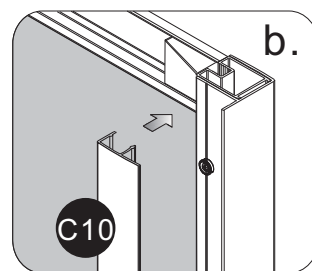
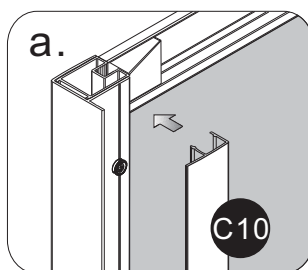
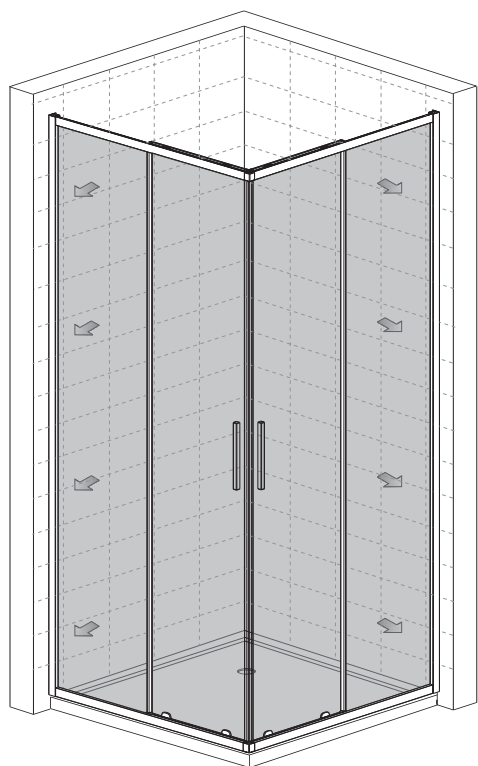

# 10.

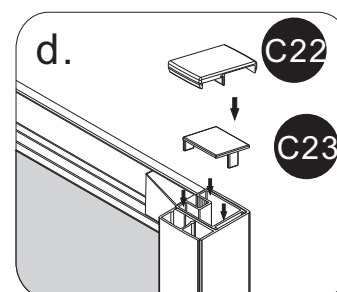
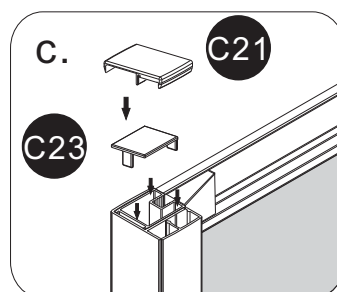
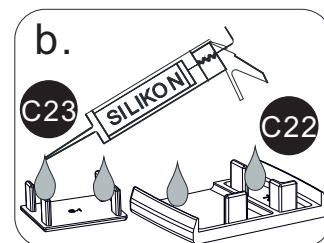
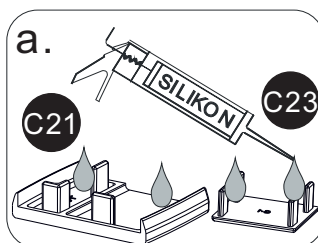
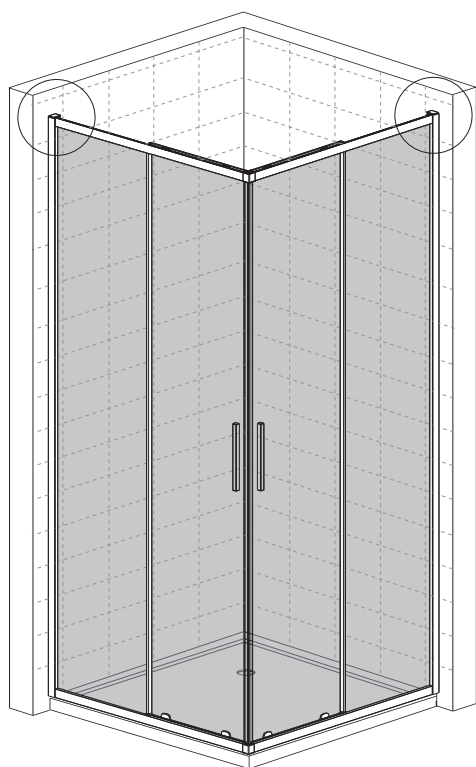

11.

